



You're safer with us

# Our Products



## MS FOSTER

SERVING THE TRANSPORTATION INDUSTRY

1040 Highway 212  
Michigan City, IN 46360

OFFICE 219.879.9225  
TOLL FREE 888.452.4053  
FAX 219.879.9313

sales@msfoster.com  
www.msfoster.com





# Zero lives lost in collisions with commercial vehicles and mobile machinery

**It's a big challenge but we are on a mission to deliver this vision.**

Brigade is at the pinnacle of commercial vehicle and mobile machinery blind-spot safety. A founder and innovator of sensing and monitoring systems that have helped save lives for over forty years.

While our portfolio may be emulated, our commitment to vehicle safety, our reliable, trusted products and our dedicated team of experts, cannot. We invest in people as well as technology. Everyone in the Brigade family understands the life-changing significance of the products and service we provide and the importance of outstanding systems that work in the most demanding of situations.

For the future: We will continue to inform and work with policy makers and industries to ensure blind-spot mitigation is effective. We will recruit the highest calibre people who are passionate about what we do. We will impart expert knowledge and advice to help customers with their challenges. We will always seek to innovate and bring new products to market that help prevent collisions and save lives. We will strive to achieve our vision of zero lives lost by constantly improving the safe operation of commercial vehicles and mobile machinery around the world.

- Brigade Electronics Group Plc management systems are certified to ISO9001:2015
- Our principal manufacturing facilities are certified to IATS16949:2016
- All applicable products have CE-marking in Europe and FCC/IC approval in North America
- The majority of our products comply with UN ECE Regulation 10 (EMC)
- Combinations of our camera monitor systems are certified to Regulation 46
- Cables are UNECE R118 compliant
- Our products comply with REACH and RoHS









# Contents



<b>Mirror-replacement systems</b>	<b>6</b>
<b>Backeye®360</b>	<b>9</b>
<b>Backeye® Camera Monitor Systems</b>	<b>13</b>
Camera Monitor Compatibility	14
Elite Range Monitors	15
Elite Range Cameras	17
Elite Range Cables	19
Elite Range Kits	20
Select Range High Definition Monitors	23
Select Range High Definition Cameras	24
Select Range High Definition Cables	26
Select Range Monitors	27
Select Range Cameras	29
Select Range Cables	32
Select Range Kits	35
Essential Range Kits	36
Adapter Cables	38
Ancillaries	40
<b>Mobile Digital Recording</b>	<b>43</b>
Bridge 4G Hosted Service	44
Recorders	45
IP Cameras	48
<b>Ultrasonic Object Detection</b>	<b>51</b>
<b>Backsense® Radar Object Detection</b>	<b>59</b>
<b>Back Up and Warning Alarms</b>	<b>65</b>
bbs-tek® White Sound Alarms	66
Quiet Vehicle Sounder	67
Speaking Alarms	68
<b>Warranties</b>	<b>71</b>
<b>Index by Model number</b>	<b>72</b>
<b>Index by Part number</b>	<b>74</b>
<b>Glossary</b>	<b>76</b>

# Backeye®eMirrors

## Mirror replacement system



**For a driver, being able to see blind spots around the vehicle is a necessity. Using a camera monitor system for visibility instead of mirrors can offer many benefits.**

Replace conventional Class II and Class IV mirrors with high-definition externally mounted side-view cameras and a pair of high definition (HD) monitors typically mounted on the A-frame inside the cab. Installation is best carried out at or by a vehicle manufacturer or bodybuilder.

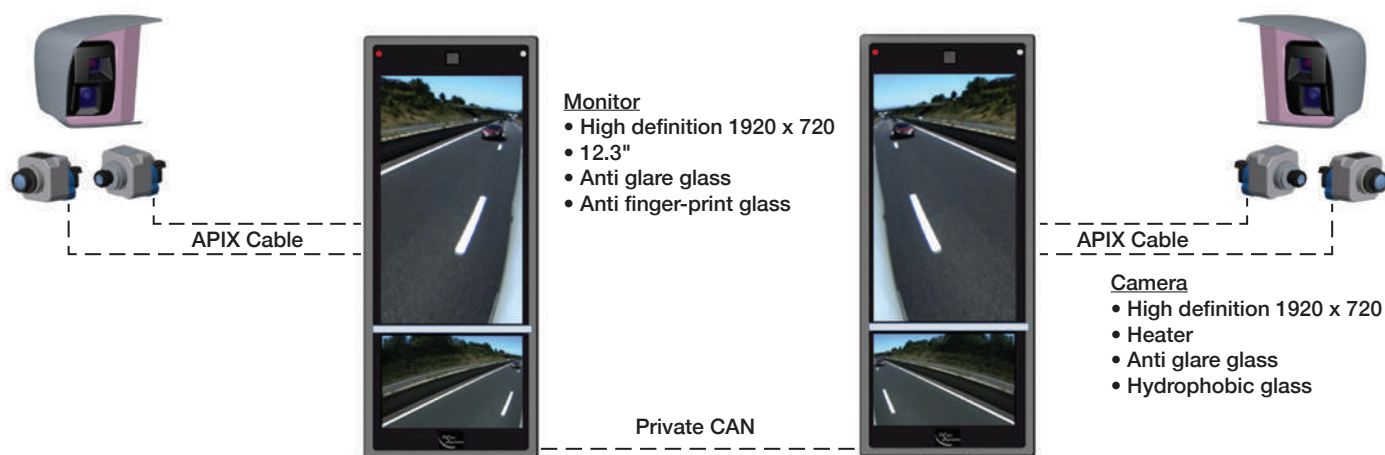

### Monitor features:

- High Definition (HD)
- Screen layout can be configured to replicate the replaced mirror positions
- Built-in light sensor for automatic screen brightness
- Monitors are linked via a private CAN network for auto-screen balance/ brightness and system operating data
- Anti glare and fingerprint glass ensures the image is always clear
- Distance markers

### Camera features:

- High Definition (HD)
- Two cameras per side/housing (Class II and Class IV or Class V)
- Cameras mounted in housing, behind heated, anti-glare, hydrophobic treated glass
- Optional integrated lens cleaning with pressurized air or water.

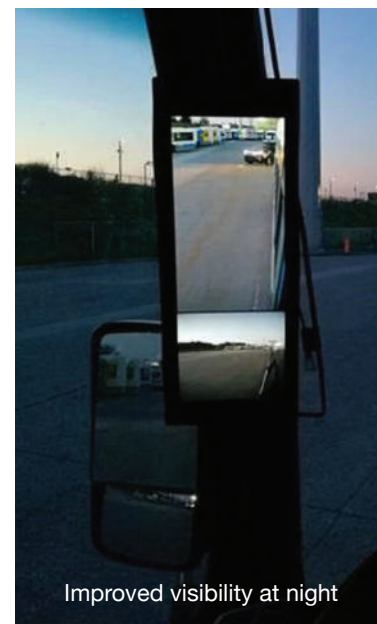
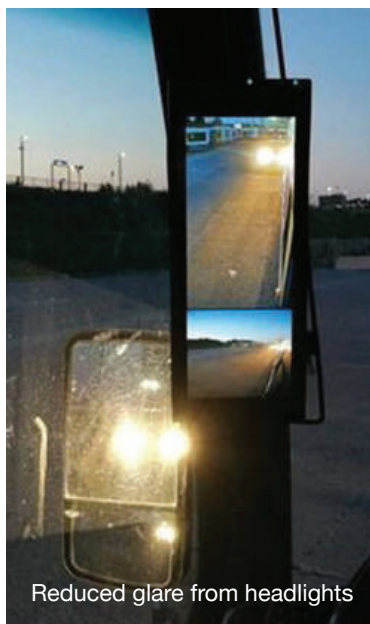

### Certification:

- UN ECE Regulation No 46 (R46), regarding devices for indirect vision and their installation. Only camera monitor systems with R46 approval may be installed in place of a compulsory mirror.
- ISO 16505
- ISO 26262





## Why install a camera monitor system in place of mirrors?

- **Wider viewing angle**

A camera has a wide viewing angle which allows the driver to see more than the minimum required field of view. A driver does not need to physically move to view a broader area as would be necessary with a conventional mirror.

- **No damage to mirrors and improved aerodynamics**

Because of their size and the distance they protrude, mirrors are prone to being hit and broken. A smaller, flush-mounted camera reduces the risk of damage, lowering maintenance costs and vehicle downtime. Replacing mirrors with cameras also improves aerodynamics which contributes to lower fuel consumption.

- **No glare and reduced light reflection**

Low sun and headlights can be dazzling for drivers, creating glare and making it difficult or impossible to define objects in mirrors. A camera system automatically adjusts to the lighting, significantly reducing glare and therefore improving driver visibility by displaying a clear image on the monitor.

- **Better visibility at night**

Night time visibility is one of the key advantages a camera system has over a conventional mirror. Low-light (low lux) capability and auto-image enhancement mean greatly improved visibility in low light conditions and a clear image on the monitor, even in almost total darkness.

- **Better visibility in the rain**

Mirrors are challenging to use in the rain. Not only does the driver need to see the vehicle and surroundings in the mirror, but through an equally wet and sometimes misted window. Water and dirt obscure the view, hugely reducing driver visibility. The camera aperture will focus through water on the lens, maintaining visibility in any type of environment or weather condition. A heated camera also helps to keep the lens free from moisture.





# Backeye®360

## 360° Camera Monitor System

### How it works

Backeye®360 is an intelligent camera monitor system designed to assist low-speed maneuvering by providing the driver with a complete 'bird's-eye' surround view of the vehicle in real time.

360° technology works with four ultra wide-angle cameras, each covering one full side of the vehicle with a viewing angle of over 180°.

High-mounted on the front, rear and sides, the calibrated cameras capture all of the surrounding area including the blind spots of the vehicle or machine.

The four live images are simultaneously sent to an electronic control unit (ECU) where they are instantly processed, combined, blended, and stitched.

The distortion from the wide-angle camera lens is also corrected so that a clear, real-time view of all around the vehicle is provided to the driver in a single image on the monitor.

Backeye®360 will work on most vehicles and machines, large or small. Our expert team of Applications Engineers can advise on installation to everything from a van to a 200 ton dump truck, including rigid and articulated trucks and buses, wheel loader, excavators, lift trucks, straddle carriers and many others.

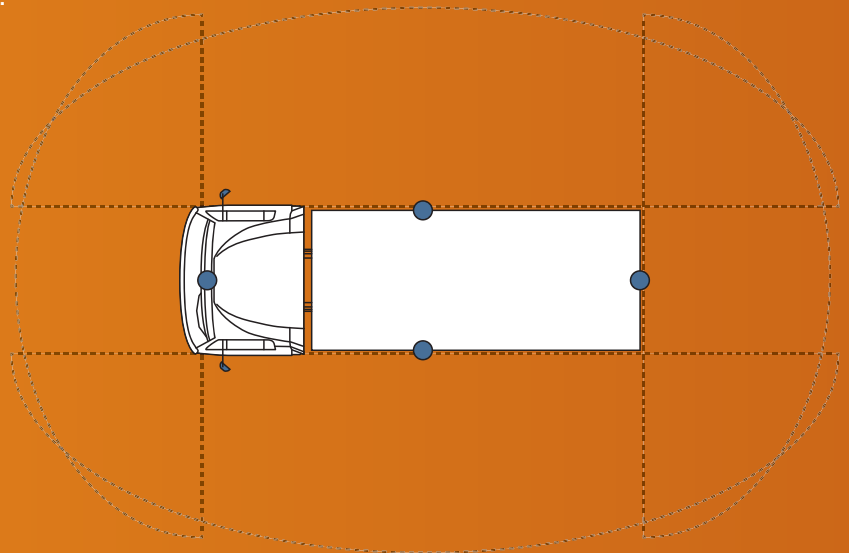

Model

Part No:

**NEW**

## AHD 360° CAMERA SYSTEM

**HD**

**BN360-300 - High Definition Backeye®360 system**

**5800**



- IP69K cameras
- 12-24Vdc
- Size (WxHxD) ECU  
178 x 113 x 26mm  
7 x 4.4 x 1 inches
- Size (WxHxD) Camera  
61 x 50 x 42mm  
2.4 x 2 x 1.7 inches
- 5 year warranty

**AHD**

### Contents

- 1 x ECU
- 4 x BN360-1000C cameras
- 1 x Video output cable to connect to SELECT range monitor
- 1 x set-up/view-select button
- 1 x ECU power harness
- 1 x ECU interface/video input harness

### Features

- 720p HD 360° image
- 15 different view modes (10 x landscape & 5 x portrait configurations)
  - Front & rear crossing-traffic
  - Customisable vehicle position
- 2 pre-defined configuration groups
- Configure & customise set up via PC calibration software
- Left, right, reverse & speed signal triggers
- Configurable on-screen parking markers
- Customisable overlay guidelines per camera view
- 2 x video outputs
- Ultra-wide viewing angle cameras (HxV) 182° x 118°
- 1/4" CMOS sensor
- Video output: AHD 1.0 and NTSC

### Power

- Power consumption: 15 Watts
- Current: 1.22 Amps

### Durability & Standards

- Mechanical vibration: 8.5G
- Mechanical shock: 51G
- Operating temperature: -30 to +75°C / -22 to +167°F
- IP30 ECU
- CE marked
- E-Marked: UNECE R10 compliant
- FCC Approved
- IC Approved
- ISO 20653:2006
- ISO 13766-1:2018

### NOTES:

- **Calibration kit is required for installation.**
- **Monitor and camera extension cables not included**
- **Individual cameras not recordable on MDR - monitor output only.**

**NEW**

## BN360-300 CABLES

**HD**

BN360-H320	HD 20m/66' camera cable	5809
BN360-H315	HD 15m/49' camera cable	5810
BN360-H310	HD 10m/33' camera cable	5811
BN360-H305	HD 5m/16' camera cable	5812
BN360-H3025	HD 2.5m/8' camera cable	5813

**NEW**

## BN360-300 360° CAMERA MONITOR SYSTEMS

**HD**

**Complete 360 AHD camera monitor system for large rigid vehicles**

**SE-770H-300 - 360 AHD camera system with VBV-770HM - 7" AHD monitor**

**6114**



- 1 x VBV-770HM AHD Monitor
- 1 x BN360-300 AHD 360 system
- 1 x BN360-H310 - 10m/33' camera cable
- 2 x BN360-H315 - 15m/49' camera cables
- 1 x BN360-H320 - 20m/66' camera cable

See individual products for detailed specifications and warranties

## BN360-200/BN360-300 MOUNTING BRACKETS



BN360-100C-BKT01	<b>Adaptable mounting bracket</b> Can be shaped to allow installation on non-vertical surfaces	4649
BN360-100C-BKT02	<b>Mounting bracket to adjust camera angle</b>	4714
BE360-CD	<b>Deflector to shield camera from knocks</b> (To be used with BN360-100C-BKT02 Mounting bracket)	4701
BN360-100C-BKT03	<b>Deflector to shield camera from knocks</b>	4743



**Model**

**Part No:**

**360° CAMERA SYSTEM**

**BN360-200 - Backeye®360 system**

**5200**



- IP69K cameras
- 12-24Vdc
- Size (WxHxD) ECU  
174 x 101 x 30mm  
6.9 x 4 x 1.2 inches
- Size (WxHxD) Camera  
61 x 46 x 36mm  
2 x 1.8 x 1.4 inches
- 5 year warranty

**MDR** COMPATIBLE **R46** APPROVED\*

**Contents**

- 1 x ECU
- 4 x BN360-100C cameras
- 1 x Video output cable to connect to SELECT range monitor.
- 1 x set-up/view-select button
- IR receiver & remote control
- 1 x ECU power harness
- 1 x ECU interface harness

**Features**

- 360° image
- 19 different view modes (max 10 views per chosen configuration group) including:
  - Landscape or portrait configurations
  - Front & rear crossing-traffic
  - Left & right lane changing assist
  - Customisable vehicle position
- 4 pre-defined configuration groups
- Configure & customise set up via monitor and IR remote control
- Left, right, reverse & speed signal triggers
- Configurable on-screen parking markers
- 3 x video outputs
- Ultra-wide viewing angle cameras (HxV) 185° x142°
- 1/3.7" CMOS sensor
- TV system: NTSC or PAL via switch on ECU (cameras NTSC only)

**Power**

- Power consumption: 8 Watts
- Current: 0.65 Amps

**Durability & Standards**

- Mechanical vibration: 8.5G
- Mechanical shock: 51G
- Operating temperature: -30 to +75°C / -22 to +167°F
- IP30 ECU
- CE marked
- E-Marked: UNECE R10 compliant
- FCC Approved
- IC Approved
- ISO 20653:2006
- ISO 13766:2006
- EN 13309:2010
- \*Camera monitor system R46 approved

**NOTES:**

- calibration kit is required for installation.
- Monitor and camera extension cables not included



**BN360-200 CABLES AND ADAPTERS**

BN360-L120	20m/66' camera cable	4493
BN360-L115	15m/49' camera cable	4495
BN360-L110	10m/33' camera cable	4496
BN360-L105	5m/16' camera cable	4498
BN360-L1025	2.5m/8' camera cable	4499
AC-305	Splitter cable for MDR (1 required per camera)	4903

**BN360-200 REQUIREMENTS FOR ARTICULATED VEHICLES**

BN360-Enclosure	IP66 Enclosure kit to enable ECU to be installed on outside of vehicle	4723
SK-15-05	Articulated vehicle cable kit for BN360-200 (3-camera)	5066

**BN360-200 360° CAMERA MONITOR SYSTEMS**

Complete 360 camera monitor system for large rigid vehicles



SE-7104F-100	360 camera system with VBV-7104FM - 10.4" monitor	5378
SE-770-100	360 camera system with VBV-770M - 7" monitor	5379



- 1 x Monitor
- 1 x BN360-200 360 system
- 1 x BN360-L110 - 10m /33' camera cable
- 2 x BN360-L115 - 15m/49' camera cables
- 1 x BN360-L120 - 20m/66' camera cable

See individual products for detailed specifications and warranties





# Backeye<sup>®</sup> Camera Monitor Systems

## A Winning Range

Camera monitor systems are used in a wide range of on and off-road applications to meet a host of health and safety and legislative requirements.

Brigade's camera monitor systems enable drivers and operators to maneuver and drive safely. Vehicle-mounted cameras can help the driver to see blind spots by delivering a live feed on the monitor of everything in the camera view, including people or obstacles.

Whether you need an entry-level reversing camera or full-vehicle camera system, we can help. With single-to-multiple camera inputs and auto-triggers, Brigade cameras and monitors will work on any application in any industry.

Brigade's camera monitor systems are compatible with its range of Mobile Digital Recorders (MDR).

### ELITE

Top of the range systems that are the first choice for Original Equipment Manufacturers (OEMs) and Bodybuilders. Exceptional quality and consistent performance in the harshest conditions. Rigorously tested to higher standards, the superior components and build quality are reflected in the Elite series' 5 year warranty. Ideal for heavy duty applications including semi-trucks, on/off-highway vehicles, agricultural machinery, and mobile mobile machinery used on Construction, Civil Engineering, Quarry and Mine sites.

### SELECT

High quality, reliable, best-selling mid-range systems. First choice in the Aftermarket and popular also with OEMs and Bodybuilders. 3 year warranty. Ideal for medium to large on-highway vehicles and smaller off-highway mobile machinery.

### ESSENTIAL

Entry level reversing solution for cost-conscious Aftermarket customers. Ideally suited for on-highway applications.

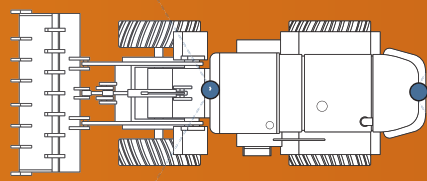



# Camera/monitor compatibility

			MONITORS			
			ELITE		SELECT	
			BE-970WFM BE-970WM BE-865DDM BE-870LM BE-870FM	BE-856GM	VBV-7104FM VBV-770FM VBV-770M VBV-750M	VBV-770M-S VBV-750M-S
✓ = Compatible						
✓ AC-035 = Compatible with adapter(s) shown						
✗ = Not compatible						
CAMERAS	ELITE	BE-810C Shutter	✓	✓ SC-1000-ECU	✓ AC-007 & SC-1000-ECU	✗
		All other Elite cameras	✓	✓	✓ AC-007	✓ AC-007
	SELECT	VBV-711C Shutter	✓ AC-035 & AC-006	✓ AC-035 & AC-006	✓ AC-035	✓
		All other Select cameras	✓ AC-006	✓ AC-006	✓	✓

## Camera icons



Infrared LEDs for ultra-low-light performance



Day/night sensor



Audio



Heater



Normal/mirror view

**WDR**

Wide Dynamic Range

**DWDR**

Digital Wide Dynamic Range

## Monitor icons



Number of camera inputs



Number of auto-triggers



Audio



'Button-lock' anti-tamper feature



On-screen distance and vertical line markers



Normal/mirror view - switching from menu

## Cable icons

(Black = solid/pins)



Male connector Select



Female connector Select



Male screw fit connector Elite



Female screw fit connector Elite



Male push fit connector Elite



Female push fit connector Elite



Male shutter connector Select



Female shutter connector Select



Male Backeye®360 connector



Female Backeye®360 connector

**Model**

**Part No:**

**7" IP69K MONITOR**

**ELITE**

**BE-970WM - Waterproof 7" Digital LCD monitor**

**3351**



- 12-24Vdc
- IP69K
- Size (WxHxD)  
194 x 124 x 48mm  
7.6 x 4.9 x 1.9 inches
- 5 year warranty



**Features**

- 2 Camera inputs
- Shutter camera compatible - both inputs
- Backlit touch screen button panel
- 'Button-lock' anti-tamper feature
- 2 Auto-triggers
- Mirror / Normal switching from menu
- On screen distance and vertical line markers
- Audio
- Sun shield
- Multi-lingual menus
- Auto-switching PAL / NTSC

**Picture Quality**

- LED backlighting (gives 20,000 hours life)
- Anti-glare screen
- Resolution: 800 x 480
- Contrast ratio: 500:1
- Brightness: 500cd/m<sup>2</sup>
- Viewing angles:  
Side 65° x Top 50° x Bottom 60°

**Power**

- Power consumption: 11 Watts
- Current: 0.9 Amps

**Durability & Standards**

- Aluminium die-cast casing
- Mechanical vibration: 20G
- Mechanical shock: 100G
- Operating temperature:  
-40 to +70°C / -40 to +158°F
- CE marked
- E-Marked: UNECE R10 compliant
- ISO 16750
- ISO 13766: 2006
- HALT tested

**7" IP69K QUAD MONITOR**

**ELITE**

**BE-970WFM - Waterproof 7" Quad digital LCD monitor**

**3560**



- 12-24Vdc
- IP69K
- Size (WxHxD)  
194 x 124 x 48mm  
7.6 x 4.9 x 1.9 inches
- 5 year warranty

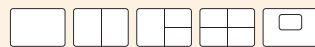

Plus additional in-built image options

**Features**

- 4 camera inputs
- Shutter camera compatible (inputs 1&2)
- Backlit touch screen button panel
- 'Button-lock' anti-tamper feature
- 5 Auto-triggers
- Mirror / Normal switching from menu
- On screen distance and vertical line markers
- Audio
- Speed switch trigger to turn monitor on/off or trigger a split screen
- Sun shield
- Multi-lingual menus
- Auto-switching PAL / NTSC

**Picture Quality**

- LED backlighting (gives 20,000 hours life)
- Anti-glare screen
- Resolution: 800 x 480
- Contrast ratio: 500:1
- Brightness: 500cd/m<sup>2</sup>
- Viewing angles:  
Side 65° x Top 50° x Bottom 60°

**Power**

- Power consumption: min 28 Watts
- Current: max 2.15 Amps

**Durability & Standards**

- Aluminium die-cast casing
- Mechanical vibration: 10G
- Mechanical shock: 100G
- Operating temperature:  
-40 to +75°C / -40 to +167°F
- CE marked
- E-Marked: UNECE R10 compliant
- ISO 16750
- ISO 20653: 2006
- HALT tested

# Elite Monitors / Cameras

Model

Part No:

## 7" QUAD MONITOR

ELITE

BE-870FM - 7" Digital LCD monitor

2146



- 12-24Vdc
- Size (WxHxD)  
197 x 135 x 30mm  
7.8 x 5.3 x 1.2 inches
- 5 year warranty

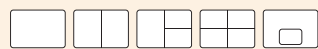

Plus additional in-built image options

### Features

- 4 camera inputs
- 5 Auto-triggers
- Shutter camera compatible
- 'Button-lock' anti-tamper feature
- Mirror / Normal switching from menu
- On-screen distance & vertical line markers
- Audio
- Sun shield
- Auto-dimmer
- Multi-lingual menus
- Auto-switching PAL / NTSC

### Power

- Power consumption: 21 Watts
- Current: 1.9 Amps

### Durability & Standards

- Mechanical vibration: 6G
- Mechanical shock: 100G
- Operating temperature:  
-40 to +70°C / -40 to +158°F
- CE marked
- E-Marked: UNECE R10 compliant
- HALT tested

### Picture Quality

- LED backlighting  
(gives 20,000 hours life)
- Anti-glare screen
- Resolution: 800 x 480
- Contrast ratio: 500:1
- Brightness: 4000cd/m<sup>2</sup>
- Viewing angles:  
Side 70° x Top 50° x Bottom 70°

## 7" MONITOR

ELITE

BE-870LM - 7" Digital LCD monitor

2705



- 12-24Vdc
- Size (WxHxD)  
197 x 128 x 34mm  
7.8 x 5 x 1.3 inches
- 5 year warranty



### Features

- 2 Camera inputs
- Shutter camera compatible - both inputs
- 'Button-lock' anti tamper feature
- 2 Auto-triggers with configurable trigger-off delays
- Mirror / Normal switching from menu
- On-screen distance and vertical line markers
- Audio
- Sun shield
- Auto-dimmer and keypad illumination
- Multi-lingual menus
- Auto-switching PAL / NTSC

- Resolution: 800 x 480
- Contrast ratio: 500:1
- Brightness: 400cd/m<sup>2</sup>
- Viewing angles:  
Side 70° x Top 50° x Bottom 70°

### Power

- Power consumption: 12 Watts
- Current: 1 Amp

### Durability & Standards

- Mechanical vibration: 2.5G
- Mechanical shock: 51G
- Operating temperature:  
-30 to +70°C / -22 to +158°F
- CE marked
- E-Marked: UNECE R10 compliant
- \*Camera monitor system R46 approved

### Picture Quality

- LED backlighting  
(gives 20,000 hours life)
- Anti-glare screen

## 5.6" MONITOR

ELITE

BE-856GM - 5.6" Digital LCD monitor

3756



- 12-24Vdc
- Size (WxHxD)  
172 x 115 x 32mm  
6.8 x 4.5 x 1.2 inches
- 5 year warranty



### Features

- 2 camera inputs
- 2 Auto-triggers
- Mirror / Normal switching from menu
- On-screen distance & vertical line markers
- Audio
- Sun shield
- Auto-dimmer
- Multi-lingual menus
- Auto-switching PAL / NTSC

- Brightness: 350cd/m<sup>2</sup>
- Viewing angles:  
Side 70° x Top 50° x Bottom 70°

### Power

- Power consumption: 11 Watts
- Current: 0.9 Amps

### Durability & Standards

- Mechanical vibration: 10G
- Mechanical shock: 50G
- Operating temperature:  
-40 to +70°C / -40 to +158°F
- CE marked
- E-Marked: UNECE R10 compliant
- ISO 13766: 2006
- ISO 16750
- HALT tested

### Picture Quality

- LED backlighting  
(gives 20,000 hours life)
- Anti-glare screen
- Resolution: 640 x 480
- Contrast ratio: 500:1



# What is WDR?

Wide Dynamic Range (WDR) automatically balances lighting in a camera image for improved detail in highlights and shadows.

This is particularly useful when working in environments where lighting quickly changes, for example; reversing into a dark loading bay on a sunny day. The transition from bright light to shadow will cause cameras that do not feature WDR to fail to pick up fine details. Areas of the picture will be bright and other areas extremely dark.

WDR Cameras balance lighting so no areas are under or over exposed, improving clarity and detail in the image.



Standard camera



WDR camera



## Model

## Part No:

### CAMERA WITH DWDR

### ELITE

**BE-901C - Integrated fisheye correction**

**5278**

**BE-991C - Integrated fisheye correction - No audio**

**5280**



- Viewing angle (HxVxD)  
100 X 65 X 106°
- IP69K/IP68
- Size (WxHxD)  
86 x 72 x 80mm  
3.4 x 2.8 x 3.2 inches
- 5 year warranty



**DWDR**

#### Features

- Intergrated image correction for wide viewing angle (fisheye) lens distortion
- Digital Wide Dynamic Range for improved detail in shadows and highlights
- 5 Infrared LEDs for ultra-low light performance
- Day / Night sensor
- Heater
- Microphone (BE-900C & BE-901C)
- Mirror / Normal view
- Automatic white balance
- Sony CMOS sensor
- TV lines: 350

#### Power

- Power consumption: 4.5 Watts
- Current: 0.36 Amps

#### Durability & Standards

- Mechanical vibration: 8.5G
- Mechanical shock: 51G
- Operating temperature:  
-40 to +70°C / -40 to +158°F
- CE marked
- E-Marked: UNECE R10 compliant
- FCC Approved
- ISO 20653:2006
- ISO 16750-4

# Elite Cameras / Cables

Model

Part No:

## CAMERA WITH WDR

ELITE



BE-801C	- NTSC	1905
BE-801C(40)	- Narrow viewing angle: 32 x 24 x 41°	2085C
BE-801C(78)	- Narrow viewing angle: 69 x 51 x 92°	2084C
BE-891C	- Waterproof to IP69K, No microphone	5426

• Viewing angle (HxVxD)  
108 x 80 x 136° NTSC

• IP68

• Size (WxHxD)  
86 x 72 x 80mm  
3.3 x 2.8 x 3.1 inches

• 5 year warranty



**R46** WDR  
APPROVED\*

### Features

- Wide Dynamic Range for improved detail in shadows and highlights
- 5 Infrared LEDs for ultra-low light performance
- Day / Night sensor
- Heater
- Microphone
- Mirror / Normal view
- Automatic white balance
- Sony CMOS sensor
- TV lines: 600

### Power

- Power consumption: 4.5 Watts
- Current: 0.33 Amps (0.37 - 2.63 Amps BE-850C)

### Durability & Standards

- Mechanical vibration: 8.5G
- Mechanical shock: 51G
- Operating temperature: -40 to +85°C / -40 to +185°F
- CE marked
- E-Marked: UNECE R10 compliant
- FCC Approved
- IC Approved
- ISO 13766:2006
- ISO 20653:2006
- EN13309:2010
- \*Camera monitor system R46 approved BE-800C, BE-890C & BE-850C only

## MINI CAMERA

ELITE



BE-821C - Mini camera (mirror image) NTSC	2002
BE-823C - Mini camera (normal image) NTSC	5100

• Viewing angle (HxVxD)  
113 x 90 x 136°

• IP68

• Size (WxHxD)  
47 x 40 x 50mm  
1.8 x 1.6 x 1.7 inches

• 5 year warranty

### Features

- Backlight compensation
- Automatic white balance
- 1/4" Sony CCD
- TV System: NTSC
- TV Lines: 600

### Power

- Power consumption: 0.9 Watts
- Current: 0.1 Amps

### Durability & Standards

- Mechanical vibration: 10G
- Mechanical shock: 100G
- Operating temperature: -40 to +80°C / -40 to +176°F
- CE marked
- E-Marked: UNECE R10 compliant
- FCC approved (NTSC models only)
- IC approved (NTSC models only)
- HALT tested
- ISO 20653:2006

**Model**

**Part No:**

**CAMERA TO MONITOR CABLES**

**ELITE**



BE-L130	- 30m / 98' cable	0800
BE-L120	- 20m / 66' cable	0801
BE-L115	- 15m / 49' cable	0802
BE-L112	- 12m / 39' cable	3008
BE-L110	- 10m / 33' cable	0803
BE-L108	- 8m / 26' cable	3007
BE-L105	- 5m / 16' cable	0804
BE-L101	- 1m / 3.3' cable	5042
BE-L1003	- 0.3m / 1' cable	2797

**ELITE CAMERA EXTENSION CABLES**

**ELITE**



BE-X025	- 25m / 82' extension cable	1907
BE-X020	- 20m / 66' extension cable	1143
BE-X015	- 15m / 49' extension cable	2101
BE-X010	- 10m / 33' extension cable	2100
BE-X005	- 5m / 16' extension cable	2099
BE-X003	- 3m / 10' extension cable	0805



**Model**

**Part No:**

## TRUCK/TRAILER CABLE KIT

**ELITE**



### SK-31E - Truck and trailer cable kit - unique pin layout

**1830**

Inclusive of SK-31E-T - Trailer kit



SP-7A

SC-7

SP-7B

- BE-L110 - 10m/32.8' cable for cab 0803
- SP-7A - 7-pin bulkhead socket for cab & cab-end camera connector (unique pin layout) 1827
- SC-7 - Coiled cable with 7-pin plugs (unique pin layout) 1829

### SK-31E-T - Trailer only kit 1886

- BE-X020 - 20m/65.6' extension cable for trailer 1143
- SP-7B - 7-pin bulkhead socket for trailer & trailer-end camera connector (unique pin layout) 1828

## TRUCK/TRAILER CABLE KIT

**ELITE**



### SK-30E - Truck and trailer cable kit

**1144**

Inclusive of SK-30E-T - Trailer kit



SP-07C

SC-07

SP-07T

- BE-L110 - 10m/32.8' cable for cab 0803
- SP-07C - 7-pin bulkhead socket for cab & cab-end camera connector 1140
- SC-07 - Coiled cable with 7-pin plugs 1046

### SK-30E-T - Trailer only kit 1885

- BE-X020 - 20m/65.6' extension cable for trailer 1143
- SP-07T - 7-pin bulkhead socket for trailer & trailer-end camera connector 1142

**Model**

**Part No:**

**TRUCK/TRAILER CABLE KIT**

**ELITE**



**SK-15-01 - Truck and trailer cable kit for three cameras**

**3427**



SP-15A-01

SC-15-01

SP-15B-01

• SP-15A-01 - 15-pin bulkhead socket for cab & 3 cab-end camera connectors

3423

• SP-15B-01 - 15-pin bulkhead socket for trailer & 3 trailer-end camera connectors

3422

• SC-15-01 - Coiled shielded cable with 15-pin plugs

3268

**TRUCK/TRAILER CABLE KIT**

**ELITE**



**SK-15-04 - Truck and trailer cable kit for single camera & single buzzer ultrasonic detection system**

**3997**



SP-15A-04

SC-15-01

SP-15B-04

• SP-15A-04 - 15-pin bulkhead socket for cab & cab-end camera connector plus stripped wires and display/buzzer connection for Ultrasonics

3955

• SP-15B-04 - 15-pin bulkhead socket for trailer & trailer-end camera connector plus stripped wires and display/buzzer connection for Ultrasonics

3956

• SC-15-01 - Coiled shielded cable with 15-pin plugs

3268

Model

Part No:

## TRUCK/DRAWBAR TRAILER CABLE KIT

ELITE

**SK-50E - Truck and drawbar trailer cable kit for two cameras  
- unique pin layout**

1570

Inclusive of SK-50E-A Truck kit and SK-31E-T trailer kit



SP-7A



SC-7

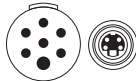

SP-7B

### SK-50E-A - Truck only kit

1879

- BE-L115 - 15m/49.2' cable for truck 0802
- BE-X005 - 5m/16.4' extension cable for truck camera 2099
- CS-020 - Two way camera selector 1571
- SP-7A - 7-pin bulkhead socket for trailer & trailer-end camera connector (unique pin layout) 1827
- SC-7 - Coiled cable with 7-pin plugs (unique pin layout) 1829

### SK-31E-T - Trailer only kit

1886

- BE-X020 - 20m/65.6' extension cable for trailer camera 1143
- SP-7B - 7-pin bulkhead socket for cab & cab-end camera connector (unique pin layout) 1828

## What is AHD?

An Analogue High Definition (AHD) camera monitor system is an analogue system that supports High Definition video resolutions. The resolution of HD & AHD systems is measured in pixels per square inch (p). AHD 1.0 supports 720p HD resolution and AHD 2.0 supports 1080p HD resolution.

### What about PAL and NTSC formats?

HD cameras operating at 25Hz (25frames per second) are compatible with PAL format (so we call them PAL). HD cameras operating at 30Hz (30 frames per second) are compatible with NTSC format (so we call them NTSC).

### What should I consider when choosing between AHD and traditional CVBS systems?

There are many factors to consider when choosing between AHD and traditional CVBS, including compatibility with other systems and bandwidth/memory capacity if connecting to a mobile digital recorder. (AHD systems will use more bandwidth for transmission and will take up more memory for the same time period). For the best HD quality results, all parts of the system should be AHD.



AHD camera image



Traditional CVBS camera image

### Compatibility with existing traditional CVBS systems:

- Brigade HD cables can be used instead of traditional CVBS cables for all Brigade SELECT camera monitor systems.
- Brigade HD cameras can be used with our MDR-500 series Mobile Digital Recorders (MDR).
- Brigade's traditional CVBS cameras can be used with our new HD monitors (camera image will not be HD).
- Brigade's traditional CVBS monitors are not compatible with HD cameras.

## Model

## Part No:

NEW

AHD 7" MONITOR

SELECT



**VB7V-770HM - 7" High Definition LCD monitor**

**5611**

- 12-24Vdc
- Size (WxHxD)  
196 x 118 x 26mm  
7.7 x 4.6 x 1 inches
- 3 year warranty



### Features

- AHD and CVBS compatible
- High-definition, high contrast, wide view angle
- 3 camera inputs
- 3 Auto-triggers
- Mirror / Normal switching from menu
- 'Button lock' anti-tamper feature
- On-screen distance markers
- Audio
- Sun shield
- Auto-dimmer
- Multi-lingual menus
- Auto-switching AHD 1.0 / AHD 2.0 / NTSC

### Picture Quality

- LED backlighting (gives 20,000 hours life)
- Anti-glare screen

- Resolution: 1024 x 600
- Contrast ratio: 700:1
- Brightness: 500cd/m<sup>2</sup>
- Viewing angles:  
Side 85° x Top 85° x Bottom 85°

### Power

- Power consumption: 10 Watts
- Current: 0.8 Amps

### Durability & Standards

- Mechanical vibration: 4G
- Mechanical shock: 51G
- Operating temperature:  
-30 to +70°C / -22 to +158°F
- CE marked
- E-Marked: UNECE R10 compliant
- HALT tested
- FCC approved
- IC approved



**Model**

**Part No:**

**NEW**

**AHD CAMERA 1080p**

**SELECT**



- VBV-7101C - High definition (1080p-NTSC)**
- VBV-7191C - No audio. High definition (1080p-NTSC)**

**5467**  
**5471**

- **Viewing angle (HxVxD)**  
110° x 60° x 127°
- **IP69K**
- **Size (WxHxD)**  
81 x 77 x 70mm  
3.2 x 3 x 2.75 inches
- **3 year warranty**



**Features**

- 4 high-power Infrared LEDs for ultra-low light performance
- Day / Night sensor
- Microphone
- Mirror view
- \* Backlight compensation
- Automatic white balance
- Sony CMOS 1/3" & Nextchip ISP
- TV System: AHD 1.0 (1080p)
- TV Lines: 800

**Power**

- Power consumption: 3 Watts
- Current: 0.2 Amps

**Durability & Standards**

- Mechanical vibration: 8.5G
- Mechanical shock: 51G
- Operating temperature:  
-30 to +80°C / -4 to +176°F
- CE marked
- E-Marked: UNECE R10 compliant
- FCC approved
- IC approved

**NEW**

**AHD CAMERA 720p**

**SELECT**



- VBV-7001C - High definition (720p-NTSC)**
- VBV-7091C - No audio. IP69K High definition (720p-NTSC)**

**5465**  
**5469**

- **Viewing angle (HxVxD)**  
107° x 64° x 126°
- **IP67**
- **Size (WxHxD)**  
81 x 77 x 70mm  
3.2 x 3 x 2.75 inches
- **3 year warranty**



**Features**

- 4 high-power Infrared LEDs for ultra-low light performance
- Day / Night sensor
- Microphone
- Mirror view
- \* Backlight compensation
- Automatic white balance
- Sony CMOS 1/3" & Nextchip ISP
- TV System: AHD 1.0 (720p)
- TV Lines: 600

**Power**

- Power consumption: 3 Watts
- Current: 0.2 Amps

**Durability & Standards**

- Mechanical vibration: 8.5G
- Mechanical shock: 51G
- Operating temperature:  
-30 to +80°C / -4 to +176°F
- CE marked
- E-Marked: UNECE R10 compliant
- FCC approved
- IC approved

Model

Part No:

**NEW**

**AHD EYEBALL CAMERA**

**SELECT**



- VBV-3001C** - High Definition Flush-mount eyeball camera  
Mirror view - (720p-NTSC)
- VBV-3021C** - High Definition Flush-mount eyeball camera  
Normal view - (720p-NTSC)

5455

5457

• **Viewing angle (HxVxD)**  
**VBV-3001C / VBV-3021C:**  
127° x 71° x 142°

• **IP69K**

• **Size (WxHxD)**  
57 x 42 x 70mm  
2.2 x 1.7 x 2.8 inches

• **3 year warranty**



**Features**

- 5 high power infrared LEDs for ultra-low light performance
- Day / Night sensor
- Lens swivel adjustment: 26° (Top) x 4° (Bottom) x 4° (Left) x 4° (Right)
- Lens rotation adjustment: ±180°
- Microphone
- Backlight compensation
- Automatic white balance
- 1/3" Sony CMOS
- TV System: AHD 1.0 (720p)
- TV lines: 600

**Power**

- Power consumption: 1.5 Watts
- Current consumption: 0.16 Amps

**Durability & Standards**

- Mechanical vibration: 8.5G
- Mechanical shock: 51G
- Operating temperature: -30 to +70°C / -22 to +158°F
- CE marked
- E-Marked: UNECE R10 compliant
- FCC approved

**OPTIONAL EXTRAS**

- SM-3XX-25** Surface mounting adapter (25mm deep)

4596

**AHD MINI CAMERA**

**SELECT**



- DMC-1031** - High definition mini camera (internal use) (720p-30fps)
- DMC-1035** - High definition mini camera (internal use) (720p-25fps)

5303

5304

• **Viewing angle (HxVxD)**  
68 x 38 x 80°

• **IP30**

• **Size (WxHxD)**  
43 x 45 x 37.5mm  
1.7 x 1.8 x 1.5 inches

• **3 year warranty**



**Features**

- Mirror / Normal view
- Backlight compensation
- Automatic white balance
- CMOS - 1/3" ON-Semi ISP - Nextchip
- TV System: AHD 1.0 (720p)
- TV Lines: 900

**Power**

- Power consumption: 1.0 Watt
- Current: 0.55 Amps

**Durability & Standards**

- Mechanical vibration: 10G
- Mechanical shock: 51G
- Operating temperature: -30 to +85°C / -22 to +185°F
- CE marked
- E-Marked: UNECE R10 compliant
- FCC approved
- IC approved

# Select AHD

Model

Part No:

## AHD DOME CAMERA

SELECT



MD-61	- High definition dome camera (720p-NTSC)	5738
MD-61(SW)	- High definition dome camera - Superwide view angle (720p-NTSC)	5690
MD-61(W)	- High definition dome camera - Wide view angle (720p-NTSC)	5698

- Viewing angle (HxVxD)  
68° x 38° x 80°  
(SW) 150° x 85° x 180°  
(W) 93° x 51° x 110°

• IP68

- Size (Diameter x H)  
76 x 59.5 mm  
3 x 2.3 inches

• 3 year warranty



### Features

- Dome camera with 150° movement range in all directions
- Can be used internally or externally
- Mirror / Normal view
- Backlight compensation
- Automatic white balance
- CMOS - 1/3" ON-Semi ISP - Nextchip
- TV System: AHD 1.0 (720p)
- TV Lines: 900
- TV Lines: 600 (SW & W)

### Power

- Power consumption: 1 Watt
- Current: 0.57 Amps

### Durability & Standards

- Mechanical vibration: 10G
- Mechanical shock 51G
- Operating temperature:  
-30 to +85°C / -22 to +185°F
- CE marked
- E-Marked: UNECE R10 compliant
- FCC Approved
- IC Approved



## OPTIONAL EXTRAS

MD-50SM-30	- Surface mounting adapter (30mm/1.2" deep)	5003
MD-50AM-15	- Angled surface mounting adapter (adds 15°)	5004
MD-50AM-25	- Angled surface mounting adapter (adds 25°)	5005

NEW

## AHD CAMERA CABLES

SELECT



VBV-H420	- 20m / 66' cable	5513
VBV-H415	- 15m / 49' cable	5514
VBV-H410	- 10m / 33' cable	5516
VBV-H405	- 5m / 16' cable	5519
VBV-H4025	- 2.5m / 8' cable	5522

**Model**

**Part No:**

**10.4" QUAD MONITOR**

**SELECT**

**VBV-7104FM - 10.4" Digital LCD Monitor**

**4474**



- 12-24Vdc
- Size (WxHxD)  
267 x 193 x 30mm  
10.5 x 7.6 x 1.2 inches
- 3 year warranty

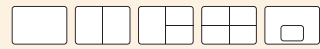

Plus additional in-built image options

**Features**

- 4 camera inputs
- 'Button-lock' anti-tamper feature
- 5 Auto-triggers
- Configurable trigger delay
- Mirror / Normal switching from menu
- On-screen distance markers
- Built-in speaker
- Sun shield
- Multi-lingual menus
- Auto-switching PAL / NTSC

**Power**

- Power consumption: 31 Watts
- Current: 2.8 Amps

**Durability & Standards**

- Mechanical vibration: 4G
- Mechanical shock: 50G
- Operating temperature:  
-20 to +70°C / -4 to +158°F
- CE marked
- E-Marked: UNECE R10 compliant
- HALT tested

**Picture Quality**

- LED backlighting  
(gives 30,000 hours life)
- Anti-glare screen
- Resolution: 1024 x 768
- Contrast ratio: 500:1
- Brightness: 400cd/m<sup>2</sup>
- Viewing angles:  
Side 70° x Top 60° x Bottom 60°

**7" MONITOR**

**SELECT**

**VBV-770M - 7" Digital LCD monitor**

**4288**

**VBV-770M-S - 7" Digital LCD monitor**

**4697**

Includes 1 x 5-pin input for connection to VBV-710C shutter camera

*Also available in High Definition model*



- 12-24Vdc
- Size (WxHxD)  
196 x 118 x 26mm  
7.7 x 4.6 x 1 inches
- 3 year warranty



**Features**

- 3 camera inputs
- 3 Auto-triggers
- Mirror / Normal switching from menu
- 'Button lock' anti-tamper feature
- On-screen distance markers
- Audio
- Sun shield
- Auto-dimmer
- Multi-lingual menus
- Auto-switching PAL / NTSC

**Power**

- Power consumption: 18 Watts
- Current: 1.5 Amps

**Durability & Standards**

- Mechanical vibration: 4G
- Mechanical shock: 100G
- Operating temperature:  
-30 to +70°C / -4 to +158°F
- CE marked
- E-Marked: UNECE R10 compliant
- HALT tested

**Picture Quality**

- LED backlighting  
(gives 20,000 hours life)
- Anti-glare screen
- Resolution: 800 x 480
- Contrast ratio: 500:1
- Brightness: 400cd/m<sup>2</sup>
- Viewing angles:  
Side 70° x Top 50° x Bottom 70°



# Select Monitors

Model

Part No:

## 5" MONITOR

SELECT



**VBV-750M - 5" Digital LCD monitor**

**4287**

**VBV-750M-S - 5" Digital LCD monitor**

**4710**

Includes 1 x 5-pin input for connection to VBV-710C shutter camera



- 12-24Vdc
- Size (WxHxD)  
149.5 x 99 x 22mm  
5.9 x 3.9 x 0.8 inches
- 3 year warranty



### Features

- 3 camera inputs
- 3 Auto-triggers
- Mirror / Normal switching from menu
- On-screen distance markers
- 'Button lock' anti-tamper feature
- Audio
- Sun shield
- Auto-dimmer
- Multi-lingual menus
- Auto-switching PAL / NTSC

### Picture Quality

- LED backlighting (gives 20,000 hours life)
- Anti-glare screen
- Resolution: 800 x 480
- Contrast ratio: 500:1
- Brightness: 350cd/m<sup>2</sup>
- Viewing angles:  
Side 70° x Top 50° x Bottom 70°

### Power

- Power consumption: 11.5 Watts
- Current: 0.95 Amps

### Durability & Standards

- Mechanical vibration: 4G
- Mechanical shock: 100G
- Operating temperature:  
-30 to +70°C / -4 to +158°F
- CE marked
- E-Marked: UNECE R10 compliant
- HALT tested

## 7" QUAD MONITOR

SELECT



**VBV-770FM - 7" Digital LCD monitor**

**4982**



- 12-24Vdc
- Size (WxHxD)  
182 x 122 x 27mm  
7.2 x 4.8 x 1 inch
- 3 year warranty

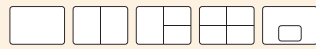

Plus additional in-built image options

### Features

- 4 camera inputs
- 'Button-lock' anti-tamper feature
- 5 Auto-triggers
- Mirror / Normal switching from menu
- On-screen distance markers
- Audio
- Sun shield
- Multi-lingual menus
- Auto-switching PAL / NTSC

### Picture Quality

- LED backlighting (gives 20,000 hours life)
- Anti-glare screen
- Resolution: 800 x 480
- Contrast ratio: 500:1
- Brightness: 400cd/m<sup>2</sup>
- Viewing angles:  
Side 70° x Top 50° x Bottom 70°

### Power

- Power consumption: 27 watts
- Current: 2.2 Amps

### Durability & Standards

- Mechanical vibration: 4G
- Mechanical shock: 50G
- Operating temperature:  
-30 to +70°C / -4 to +158°F
- CE marked
- E-Marked: UNECE R10 compliant

## CAMERA MONITOR SYSTEM ANCILLARIES

SELECT



**BMM-019-ARM - 68mm/2.7" replacement arm (Select range)**

**3348**

- 68mm/2.7" mounting bracket arm
- Allows monitor to be dash-mounted in portrait position

A further range of camera/monitor brackets and mounting adapters is available. Please contact us for details

**Model**

**Part No:**

**CAMERA**

**SELECT**



**VBV-701C - NTSC**

**2575**

**VBV-791C - Waterproof to IP69K, no audio NTSC**

**2842**

*Also available in High Definition (720p & 1080p) models*

- Viewing angle (HxVxD)  
86 x 72 x 122°
- IP67
- Size (WxHxD)  
81 x 77 x 70mm  
3.2 x 3 x 2.8 inches
- 3 year warranty



**Features**

- 4 high-power Infrared LEDs for ultra-low light performance
- Day / Night sensor
- Microphone
- Mirror view
- \* Backlight compensation
- Automatic white balance
- 1/3" Sharp CCD
- TV Lines: 750

**Power**

- Power consumption: 3 Watts
- Current: 0.2 Amps

**Durability & Standards**

- Mechanical vibration: 10G
- Mechanical shock: 51G
- Operating temperature:  
-30 to +70°C / -22 to +158°F
- CE marked
- E-Marked: UNECE R10 compliant
- FCC approved
- HALT tested

**SHUTTER CAMERA**

**SELECT**



**VBV-711C - Shutter camera**

**2808**

Direct connection to VBV-770M-S and VBV-750M-S monitors via 5-pin 10m (VBV-L510) or 20m (VBV-L520) camera cable.

- Viewing angle (HxVxD)  
98 x 73 x 108°
- IP68 / IP69K
- Size (WxHxD)  
122 x 85 x 82mm  
4.8 x 3.3 x 3.2 inches
- 3 year warranty



**Features**

- 4 high power infrared LEDs for ultra-low light performance
- Day / Night sensor
- Automatic Shutter
- Heater
- Microphone
- Mirror / Normal view
- Backlight compensation
- Automatic white balance
- 1/3" Sharp CCD
- TV System: PAL
- TV Lines: 580

**Power**

- Max Power consumption: 6 Watts
- Max Current: 0.5 Amps

**Durability & Standards**

- Mechanical vibration: 10G
- Mechanical shock: 50G
- Operating temperature:  
-30 to +70°C / -22 to +158°F
- CE Marked
- E-Marked: UNECE R10 compliant

# Select Cameras

Model

Part No:

## EYEBALL CAMERA

SELECT



- VBV-301C - Flush-mount eyeball camera - Mirror view - NTSC
- VBV-321C - Flush-mount eyeball camera - Normal view - NTSC

5213  
5217

Also available in High Definition (720p) models

• Viewing angle (HxVxD)  
111 x 80 x 153°

• IP69K

• Size (WxHxD)  
57 x 42 x 70mm  
2.2 x 1.7 x 2.8 inches

• 3 year warranty



### Features

- 5 high power infrared LEDs for ultra-low light performance
- Day / Night sensor
- Lens swivel adjustment: 26° (Top) x 4° (Bottom) x 4° (Left) x 4° (Right)
- Lens rotation adjustment: ±180°
- Microphone
- Backlight compensation
- Automatic white balance
- 1/3" Sharp CCD
- TV System: NTSC
- TV lines: 600

### Power

- Power consumption: 2.3 Watts
- Current consumption: 0.16 Amps

### Durability & Standards

- Mechanical vibration: 8.5G
- Mechanical shock: 51G
- Operating temperature: -30 to +70°C / -22 to +158°F
- CE marked
- E-Marked: UNECE R10 compliant
- FCC approved

## OPTIONAL EXTRAS

SM-3XX-25 Surface mounting adapter (25mm/82" deep)

4596

## CYLINDER CAMERA

SELECT



VBV-481C - Cylinder camera NTSC

2843

• Viewing angle (HxVxD)  
96 x 71 x 126°

• IP69K/IP68

• Size (Diameter x Length)  
35 x 50mm  
1.4 x 2 inches

• 3 year warranty



### Features

- 9 LEDs for ultra-low light performance
- Day/night sensor
- Mirror view
- Backlight compensation
- Auto white balance
- 1/3" Sharp CCD
- TV Lines: 800

### Power

- Power consumption: 1.9 Watts
- Current: 0.2 Amps

### Durability & Standards

- Mechanical vibration: 10G
- Mechanical shock: 50G
- Operating Temperature: -30 to +70°C / -22 to +158°F
- E-Marked: UNECE R10 compliant
- CE marked
- FCC approved VBV-481C only
- IC approved VBV-481C only

**Model**

**Part No:**

**DOME CAMERA**

**SELECT**



<b>MD-51</b>	- Dome Camera NTSC	<b>5736</b>
<b>MD-51(SW)</b>	- Dome Camera - Superwide view angle NTSC	<b>5686</b>
<b>MD-51(W)</b>	- Dome Camera - Wide view angle - NTSC	<b>5694</b>

*Also available in High Definition (720p) models*

• **Viewing angle (HxVxD)**  
**(SW) 150° x 85° x 180°**  
**(W) 93° x 51° x 110°**

• **IP68**

• **Size (Diameter x H)**  
**76 x 59.5 mm**  
**3 x 2.3 inches**

• **3 year warranty**



**Features**

- Dome camera with 150° movement range in all directions
- Can be used internally or externally
- Mirror / Normal view
- Backlight compensation
- Automatic white balance
- CMOS - 1/3" ON-Semi ISP - Nextchip
- TV System: NTSC
- TV Lines: 600

**Power**

- Power consumption: 1 Watt
- Current: 0.57 Amps

**Durability & Standards**

- Mechanical vibration: 10G
- Mechanical shock 51G
- Operating temperature: -30 to +85°C / -22 to +185°F
- CE marked
- E-Marked: UNECE R10 compliant
- FCC Approved
- IC Approved



**OPTIONAL EXTRAS**

<b>MD-50SM-30</b>	- Surface mounting adapter (30mm/1.2" deep)	<b>5003</b>
<b>MD-50AM-15</b>	- Angled surface mounting adapter (adds 15°)	<b>5004</b>
<b>MD-50AM-25</b>	- Angled surface mounting adapter (adds 25°)	<b>5005</b>

**MINI CAMERA**

**SELECT**



<b>DMC-1021</b>	- Mini camera (internal use) NTSC	<b>5715</b>
-----------------	-----------------------------------	-------------

*Also available in High Definition (720p) models*

• **Viewing angle (HxVxD)**  
**68 x 38 x 80°**

• **IP30**

• **Size (WxHxD)**  
**43 x 45 x 37.5mm**  
**1.7 x 1.8 x 1.5 inches**

• **3 year warranty**



**Features**

- Mirror / Normal view
- Backlight compensation
- Automatic white balance
- CMOS - 1/3" ON-Semi ISP - Nextchip
- TV System: NTSC
- TV Lines: 600

**Power**

- Power consumption: 1.0 Watt
- Current: 0.55 Amps

**Durability & Standards**

- Mechanical vibration: 10G
- Mechanical shock: 51G
- Operating temperature: -30 to +60°C / -22 to +140°F
- CE marked
- E-Marked: UNECE R10 compliant
- FCC approved
- IC approved





# Select Cameras

Model

Part No:

## SELECT CAMERA CABLES

## SELECT



VBV-L430	- 30m / 98' cable	2108
VBV-L420	- 20m / 66' cable	1380
VBV-L415	- 15m / 49' cable	3150
VBV-L412	- 12m / 39' cable	3106
VBV-L410	- 10m / 33' cable	1386
VBV-L407	- 7m / 23' cable	3151
VBV-L406	- 6m / 20' cable	3152
VBV-L405	- 5m / 16' cable	1499
VBV-L403	- 3m / 10' cable	4977
VBV-L4025	- 2.5m / 8' cable	1554



VBV-L520	- 20m / 66' 5-pin shutter camera cable	3664
VBV-L510	- 10m / 33' 5-pin shutter camera cable	3663
VBV-L505	- 5m / 16' 5-pin shutter camera cable	4001

**Model**

**Part No:**

**TRUCK/TRAILER CABLE KIT**

**SELECT**

**SK-15-05 - Truck and trailer cable kit for 3-camera Backeye®360**

**5066**



- SP-15A-05 - 15-pin bulkhead socket for cab & cab-end connector plus 3x connections for Backeye®360 Select 5064
- SP-15B-05 - 15-pin bulkhead socket for trailer & trailer-end connector plus 3x connections for Backeye®360 Select 5065

- SC-15-01 - Coiled shielded cable with 15-pin plugs 3268

**TRUCK/ DRAWBAR TRAILER CABLE KIT**

**SELECT**

**VSK-50E - Truck and drawbar trailer cable kit for two cameras**

**2540**

*Inclusive of VSK-50E-A Truck kit and VSK-30E-T Trailer kit*



**VSK-50E-A - Truck only kit 2541**

**VSK-30E-T - Trailer only kit 2542**

- VBV-L420 - 20m/66' cable for truck 1380
- VBV-L405 - 5m/16' camera cable for truck camera 1499
- VCS-020 - Two-way camera selector 1844
- 1 x VSP-47A - 7-pin camera bulkhead socket for truck rear 1847
- SC-07-24S - Coiled cable with 7-pin sockets 1227

- VBV-L420 - 20m/66' cable for trailer 1380
- VSP-47B - 7-pin camera bulkhead socket for trailer 1846



**TRUCK/DRAWBAR TRAILER CABLE KIT**

**SELECT**

**VSK-505E - Truck and drawbar trailer cable kit for two Select shutter cameras**

**4005**



- VBV-L420 - 20m/66' cable for truck 1380
- VBV-L520 - 20m/66' camera cable for truck camera 3664
- VBV-L505 - 5m/16' camera cable for cab 4001
- VCS-020 - Two-way camera selector 1844
- 2 x AC-035 - 5-pin to 4-pin shutter camera adapter 3702

- VSP-57A - 7-Pin bulkhead socket for cab & cab-end camera connector 3869
- VSP-57B - 7-pin bulkhead socket for trailer & trailer-end camera connector 3870
- SC-07-24S - Coiled cable with 7-pin plugs 1227



# Select Cables

Model

Part No:

## TRUCK/TRAILER CABLE KIT

SELECT



**VSK-31E - Truck and trailer cable kit - unique pin layout**  
Inclusive of VSK-31E-T - Trailer kit

2539



SP-7A SC-7 SP-7B  
(Select connector via supplied adapter cables)

- VBV-L410 - 10m/33' cable for cab 1386
- SP-7A - 7-pin bulkhead socket for cab & cab-end camera connector (unique pin layout) 1827
- AC-014 - Adapter cable 2094
- SC-7 - Coiled cable with 7-pin plugs (unique pin layout) 1829

**VSK-31E-T - Trailer only kit 2543**

- VBV-L420 - 20m/66' cable for trailer 1380
- AC-006 - Adapter cable 1983
- SP-7B - 7-pin bulkhead socket for trailer & trailer-end camera connector (unique pin layout) 1828

## TRUCK/TRAILER CABLE KIT

SELECT



**VSK-30E - Truck and trailer cable kit**  
Inclusive of SK-30E-T - Trailer only kit

2538



VSP-47A SC-07-24S VSP-47B

- VBV-L410 - 10m/33' cable for cab 1386
- VSP-47A - 7-pin bulkhead socket for cab & cab-end camera connector 1847
- SC-07-24S - Coiled cable with type 24S 7-pin plugs 1227

**VSK-30E-T - Trailer only kit 2542**

- VBV-L420 - 20m/66' extension cable for trailer 1380
- VSP-47B - 7-pin bulkhead socket for trailer & trailer-end camera connector 1846

## TRUCK/TRAILER CABLE KIT

SELECT



**VSK-305E - Truck and trailer cable kit for Select shutter camera**

3871



VSP-57A SC-07-24S VSP-57B

- VBV-L510 - 10m/33' cable for cab 3663
- VBV-L520 - 20m/66' cable for trailer 3664
- VSP-57A - 7-pin bulkhead socket for cab & cab-end camera connector 3869

**VSP-57B - 7-pin bulkhead socket for trailer & trailer-end camera connector 3870**

- SC-07-24S - Coiled cable with type 24S 7-pin plugs 1227

**Model**

**Part No:**

**CAMERA MONITOR SYSTEMS**

**SELECT**

**VBV-770-301 - Single flush-mount camera monitor system for rigid vehicles**

**4779**



- VBV-770M - 7" monitor **4288**
- VBV-301C - flush-mount camera **5213**
- VBV-L420 - 20m/66' cable **1380**

See individual products for detailed specifications and warranties

**VBV-770-000N - Single camera monitor system for rigid vehicles**

**4693**



- VBV-770M - 7" monitor **4288**
- VBV-701C - camera **2575**
- VBV-L420 - 20m/66' cable **1380**

See individual products for detailed specifications and warranties

**VBV-750-000N - Single camera monitor system for rigid vehicles**

**4706**



- VBV-750M - 5" monitor **4287**
- VBV-701C - camera **2575**
- VBV-L420 - 20m/66' cable **1380**

See individual products for detailed specifications and warranties

**OPTIONAL EXTRA**

Add VBV-301C (low mount) or VBV-321C (high mount) side view camera + VBV-L405 (5m/16' cable) to spot cyclists.





# Select/Essential Kits

Model

Part No:

## CAMERA MONITOR SYSTEMS

SELECT

**VBV-770-311 - Single flush-mount camera monitor system for small rigid and vans 4783**



- VBV-770M - 7" monitor **4288**
- VBV-301C - Flush-mount eyeball camera **5211**
- VBV-L410 - 10m/33' cable **1386**

See individual products for detailed specifications and warranties

**VBV-750-311 - Single flush-mount camera monitor system for rigid vehicles 4782**



- VBV-750M - 5" monitor **4287**
- VBV-301C - Flush-mount eyeball camera **5211**
- VBV-L410 - 10m/33' cable **1386**

See individual products for detailed specifications and warranties

**VBV-750-910 - Single camera monitor system for vans 4220**



- VBV-750M - 5" color monitor
- VBV-791C - color camera
- VBV-L410 - 10m / 33' cable

See individual products for detailed specifications and warranties

**VBV-770-910 - Single camera monitor system for vans 4221**



- VBV-770M - 7" color monitor
- VBV-791C - IP69K color camera
- VBV-L410 - 10m / 33' cable

See individual products for detailed specifications and warranties

## ESSENTIAL MONITOR

ESSENTIAL

**VBV-243M - 4.3" Digital Mirror monitor 5323**



- 12-24Vdc
- Size (WxDxH)  
280 x 92 x 30.5mm  
11 x 3.6 x 1.2 inches
- 1 year warranty



### Features

- On screen multi-lingual display menu
- Digital LCD panel
- 2 Auto-trigger
- Auto dimmer
- Illuminated keypad
- On-screen distance markers
- TV system: PAL / NTSC

### Picture Quality

- Resolution: 480 x 272
- Contrast ratio: 600:1
- Brightness: 1000cd/m<sup>2</sup>
- Viewing angles:  
Side 65° x Top 60° x Bottom 50°

### Power

- Power consumption: 6.6 Watts
- Current: 0.53 Amps

### Durability & Standards

- Vibration rating: 6G
- Operating temperature:  
-20 to +70°C / -4 to +158°F
- CE marked
- FCC approved

Model

Part No:

**NEW**

**CAMERA MONITOR SYSTEM**

**ESSENTIAL**

**VBV-671-000 - NTSC Camera monitor system**

**5816**

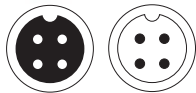

- **Camera Viewing angle (HxVxD)**  
89 x 65 x 114°
- **IP67**
- **Camera Size (WxHxD)**  
76 x 59 x 52mm  
3 x 2.3 x 2 inches
- **Monitor Size (WxHxD)**  
205 x 126 x 26mm  
8 x 5 x 1 inches
- **1 year warranty**



**Contents**

- 1 x VBV-670M monitor
- 1 x monitor sunshield
- 1 x monitor bracket
- 1 x VBV-63XC camera
- 1 x 20m VBV-L4020 extension cable
- Fitting kit

**Camera Features**

- Normal view
- 1/3" PixelPlus CMOS
- TV Lines: 425

**Monitor Features**

- 2 camera inputs
- 1 auto trigger
- Sun shield
- Multi-lingual menus
- Normal/Mirror via OSD menu

**Picture Quality**

- Monitor resolution: 800x400
- Contrast ratio: 500:1
- Brightness: 250 cd/m<sup>2</sup>
- Monitor viewing angles:  
Side 70° x Top 45° Bottom 65°

**Power**

- Power consumption: 4.2 Watts
- Current: 0.4 Amps

**Durability & Standards**

- Mechanical vibration:  
Camera: 8.5G Monitor: 4G
- Operating temperature:  
-30 to +70°C / -4 to +158°F
- CE marked
- FCC approved



**TO CONNECT AN ADDITIONAL CAMERA**

**VBV-631C - Essential Camera - NTSC**

**5817**

**VBV-L4020 - 20m/66" Essential extension cable**

**5773**

**CAMERA MONITOR SYSTEM**

**ESSENTIAL**

**VBV-650-000N - NTSC Single-camera monitor system**

**4766**

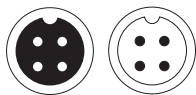

- **Camera Viewing angle (HxVxD)**  
81 x 59 x 108°
- **IP67**
- **Camera Size (WxHxD)**  
65 x 59 x 55mm  
2.5 x 2.3 x 2 inches
- **Monitor Size (WxHxD)**  
150 x 99 x 31mm  
6 x 4 x 1.2 inches
- **1 year warranty**



**Contents**

- 1 x VBV-670M monitor
- 1 x monitor bracket
- 1 x VBV-621C camera
- 1 x 20m VBV-L4020 extension cable
- Fitting kit

**Camera Features**

- Mirror view
- CMOS
- TV Lines: 420

**Monitor Features**

- 1 camera input

**Picture Quality**

- Monitor resolution: 640x480
- Monitor viewing angles:  
Side 70° x Top 50° Bottom 70°

**Power**

- Power consumption: 2 Watts

**Durability & Standards**

- Operating temperature:  
-30 to +70°C / -4 to +158°F



































# Adapter Cables





















**Model**

**Part No:**

## BRIGADE CAMERA MONITOR ADAPTERS

	 	AC-006 - Connects Select camera (not shutter) to Elite cable	1983
	 	AC-007 - Connects Select monitor to Elite cable	1984
	 	AC-014 - Connects Elite camera to Select cable	2094
	 	AC-014(5M) - Connects Elite camera to Select cable, 5m/16.4' long	5049
	 	AC-020 - Connects Elite monitor to Select cable	2590
	 	AC-035 - 5-pin to 4-pin Select shutter camera adapter	3702
	 	AC-055(5M) - 5-pin to 4-pin Select cable, 5m long	4267
	  	AC-305 - Splitter cable connects 1 x BN360-200 camera to MDR & ECU	4903
	  	AC-306 - Splitter cable connects 1 x (Non HD) Select camera to MDR & monitor	4904
	  	AC-307 - Splitter cable connects 1 x Elite camera to MDR & Monitor	4905

## MISCELLANEOUS CAMERA MONITOR ADAPTERS

	 	AC-056 - Connects Select camera to Orlaco monitor	4401
	 	AC-062 - Connects Elite camera to Orlaco monitor	4691
	 	AC-063 - Connects Elite camera to Orlaco monitor, screw fit	4925
	 	AC-066 - Connects Orlaco camera to Elite monitor	5027
	 	AC-067 - Connects Orlaco camera to Select monitor	5028
	 	AC-24-12(009) - In-line 24/12Vdc converter - Select camera to Mekra 507405 monitor	4926
	 	AC-308 - Splitter cable to connect MDR to Mekra 507405 CMS	4949

**Model**
**Part No:**
**OEM CAMERA MONITOR ADAPTERS**

		<b>AC-041 - Connects Elite camera to John Deere 7-pin amp output</b>	<b>4245</b>
		<b>AC-042 - Connects Select camera to John Deere 7-pin amp output</b>	<b>4246</b>
		<b>AC-044 - Connects Select camera to Molex M12 (Fendt)</b>	<b>4279</b>
		<b>AC-045 - Connects Elite camera to Molex M12 (Fendt)</b>	<b>4280</b>
		<b>AC-068 - Connects Select camera to MAN Harman unit with camera prep</b>	<b>5234</b>
		<b>AC-069 - Connects Select camera to MAN/Scania Harman unit without camera prep</b>	<b>5318</b>
		<b>AC-24-12(002) - In-line 24/12Vdc converter - Elite camera to Mercedes monitor</b>	<b>4266</b>
		<b>AC-24-12(004) - In-line 24/12Vdc converter - Select camera to MAN MMT HSD</b>	<b>4281</b>
		<b>AC-24-12(006) - In-line 24/12Vdc converter - Select camera to Volvo FH(4) &amp; FM(4)</b>	<b>4719</b>
		<b>AC-24-12(007) - In-line 24/12Vdc converter - Select camera to Iveco connect system</b>	<b>4762</b>
	<b>AC-24-12(008) - In-line 24/12Vdc converter - Select camera to Mercedes Sprinter</b>	<b>4763</b>	

A further range of OEM-specific adapters to connect Brigade cameras to factory-fit monitors is available

**GENERAL CAMERA MONITOR ADAPTERS**

		<b>AC-016 - Connects AV to Camera input of Elite monitor</b>	<b>2150</b>
		<b>AC-019 - Connects Elite camera to male phono (video only)</b>	<b>2589</b>
		<b>AC-021 - Connects BNC/FLIR PathFindIR camera to Elite cable</b>	<b>2704</b>
		<b>AC-024 - Connects AV to Select monitor</b> <small>(video &amp; audio input, 12Vdc output)</small>	<b>3183</b>
		<b>AC-028 - Connects AV to Select cable</b>	<b>3335</b>
	<b>AC-064 - Connects Elite camera to BNC adapter cable</b>	<b>4948</b>	



**Model**

**Part No:**

## DIGITAL WIRELESS CONNECTION SYSTEM

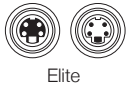

Elite



Select

**DW-1001-TX - Digital Wireless Transmitter**  
**DW-1001-RX - Digital Wireless Receiver**

**4282**  
**4283**

- Digital technology
- 12-24Vdc
- 1 camera input
- IP69K (Transmitter)
- Size (WxHxD)  
113 x 114 x 31mm  
4.4 x 4.5 x 1.2 inches
- 3 year warranty

**Features**

- Image Latency: 200 milliseconds
- No need for retractable coiled cables
- Reduces installation time
- Re-pair facility allows for interchangeable trailers
- Triggered by reverse gear
- TV System: NTSC
- Secure connection

**Power**

- Maximum Current Amps:  
TX: 0.85 RX: 0.17
- Power consumption:  
TX: 9.8 Watts RX: 2.2 Watts

**Durability & Standards**

- Operating temperature:  
-40 to +70°C / -40 to +158°F
- Mechanical vibration: 6G
- Mechanical shock: 20G
- CE marked
- E-Marked: UNECE R10 compliant

Includes connectors/adapters for both Elite and Select range cameras and monitors. Not AHD compatible

## CAMERA MONITOR SYSTEM ANCILLARIES



Elite



Select



**CS-020 - Two-way camera selector (Elite range connectors)**  
**VCS-020 - Two-way camera selector (Select range connectors)**

**1571**  
**1844**

- Allows a 2nd camera to be connected to a monitor
- 2nd camera view selected by trigger wire
- Full screen view only
- 2 year warranty

Not AHD compatible

## CAMERA MONITOR SYSTEM ANCILLARIES



**LS-60-A - Speed switch**

**4851**

- 12-24Vdc
- Auto-triggers safety equipment at the designated speed
- Size (WxHxD)  
44 x 16 x 64mm  
1.7 x 0.6 x 2.5 inches
- 2 year warranty

**Features**

- Normally closed - safety device on by default, turning off at designated speed
- 10 speed threshold settings
- Compact size
- Easy to install and set up
- Short circuit protection on camera inputs
- Reverse polarity protected

**Power**

- Power consumption: 21.6 Watts
- Max current: 1.8 Amps
- Switch Output max. current: 1.2 Amps

**Durability & Standards**

- Mechanical vibration: 10G
- Mechanical shock: 50G
- Operating temperature:  
-40 to +85°C / -40 to +185°F
- CE marked
- E-Marked: UNECE R10 compliant

**Notes:**

- A relay is required if connected to a device that is higher than 1.2 Amps
- Not compatible with HD systems

**Model**

**Part No:**

**CAMERA MONITOR SYSTEM ANCILLARIES**

**SELECT**

**SS-002 - Twin camera screen splitter (Select range connectors)**

**3044**

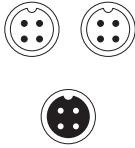

- 12-24Vdc
- 2 camera inputs
- Size (WxHxD)  
147 x 37 x 78mm  
5.7 x 1.5 x 3 inches
- 2 year warranty

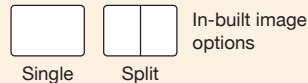

**Features**

- Offers split-screen option for monitors without in-built functionality
- 3 trigger inputs per camera
- Shutter camera compatible with adapters (Elite - AC-035) (Select - TS-1000-ECU)
- TV System: NTSC
- Manual Mirror/Normal switching - choose from horizontal normal/mirror or vertical normal/flip
- Short circuit protection on camera inputs
- Reverse polarity protected

**Power**

- Power Consumption: 8.4 Watts
- Current: 0.7 Amps

**Durability & Standards**

- Mechanical vibration: 10G
- Mechanical shock: 50G
- Operating temperature: -30 to +70°C / -22 to +158°F
- CE marked
- E-Marked: UNECE R10 compliant
- FCC approved
- IC approved

Adapter required for Elite range monitors  
Not AHD compatible

**CAMERA MONITOR SYSTEM ANCILLARIES**

**ELITE**

**EDM-50 - Multi-camera module and screen splitter (Elite range connectors)**

**2152**



- 12-24Vdc
- 4 camera inputs
- Size (WxHxD)  
154 x 28 x 105mm  
6 x 1.1 x 4.1 inches
- 2 year warranty

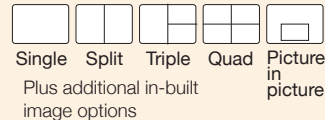

**Features**

- Shutter camera compatible (inputs 1,2&3)
- AV input to accept DVD, sat nav or other add-ons
- 5 manual or auto-triggers for each camera
- On screen distance markers
- Mirror / Normal image switch for each camera
- Selectable camera audio
- Auto-scanning function
- Adapter required for Select range monitors

**Power**

- Power consumption: 20 Watts
- Current: 2 Amps

**Durability & Standards**

- Mechanical vibration: 5G
- Operating temperature: -25 to +70°C / -13 to +158°F
- CE marked
- E-Marked: UNECE R10 compliant

Not AHD compatible



# MDR

# Mobile Digital Recording

## Providing your witness

Brigade's Mobile Digital Recording (MDR) systems are now capable of capturing vehicle data and footage from up to 16 vehicle-mounted cameras. The MDR range includes models with 4G and WiFi connectivity capabilities, allowing data to be accessed from the recorder without having to physically go to the vehicle.

To take full advantage of the benefits of 4G connectivity, Brigade has launched Bridge, a fully managed service for 4G enabled systems so that operators do not have to set up and maintain their own servers and manage SIMs and mobile data.

New IP Cameras and Network Expansion Modules mean that up to 6 cameras can be connected to our 4-channel MDR and up to 16 cameras can be connected to our 8-channel MDR.

MDRs are compatible with all Brigade Backeye® camera monitor systems, including Backeye®360 – BN360-200 and IP Cameras. .

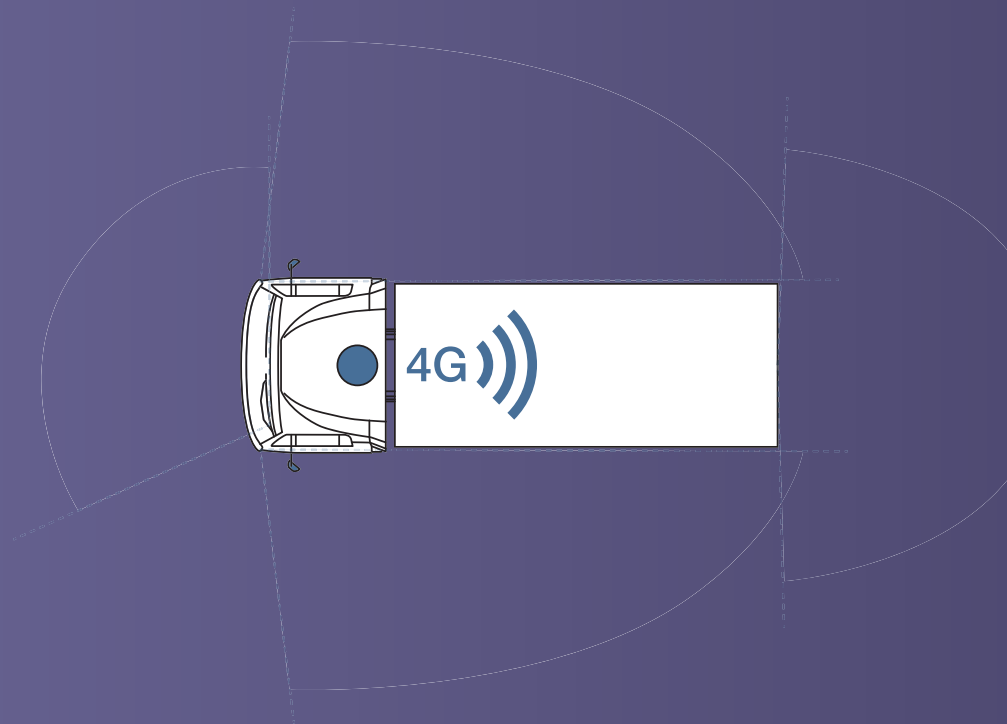



# BRIDGE

## MDR 4G Hosted Service

The MDR range includes models with 4G connectivity capabilities, allowing data to be accessed from the recorder without having to physically go to the vehicle.

To take full advantage of the benefits of 4G connectivity, Brigade has launched Bridge, a fully managed service for 4G enabled systems so that operators do not have to set up and maintain their own servers and manage SIMs and mobile data.



### Benefits of having remote access to the MDR can include:

- **Playback of historical footage and metadata from MDR or server** - Metadata includes: GPS location, speed, G-force, events and alarms.
- **Vehicle tracking** - Includes: GPS location, speed and alarms. Dual-screen support with dedicated location map.
- **Live view of vehicle cameras and metadata** - Metadata includes: GPS location, speed and alarms. Up to 64 cameras can be viewed from multiple MDRs on one screen.
- **Download footage**
  - **Scheduled:** one-off download to the server that will commence once vehicle is online.
  - **Automatic:** Pre-alarm and post-alarm footage (e.g. 30 seconds) will automatically save to the server.
  - **Manual:** Download historical footage from the MDR to local storage.
- **Geo-fencing** - Easily set up geographical boundaries to know when your vehicle enters and/or leaves areas.

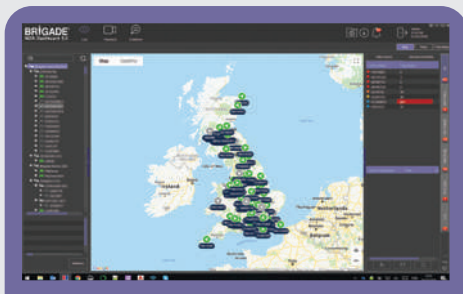

Vehicle Tracking on MDR Dashboard  
PC software and MDR App



Example of 4-channel playback  
MDR Dashboard PC software

### All Bridge packages include

- 4G connection
- Competitively-priced 12 month contract, rolling thereafter
- SIM card
- Remote access to MDR via secure cloud server
- Technical helpline and online tutorials
- Access to data via MDR Apps for iOS and Android systems
- Access to data via MDR Dashboard PC software: Windows OS required (minimum Windows 7)





For further information, visit [brigade-electronics.com/bridge](http://brigade-electronics.com/bridge)

At the time of print, 4G Hosted Services only available in selected countries.

**Model**

**Part No:**

**MOBILE DIGITAL RECORDER**

<b>MDR-508-2000</b>	- 8 channel 2TB hard disk recorder	<b>5577</b>
<b>MDR-508-1000</b>	- 8 channel 1TB hard disk recorder	<b>5126</b>
 	<b>MDR-508GW-2000</b> - 8 channel 2TB hard disk recorder with WiFi and 4G	<b>5556</b>
	<b>MDR-508GW-1000</b> - 8 channel 1TB hard disk recorder with WiFi and 4G	<b>5127</b>
	<b>MDR-508G-2000</b> - 8 channel 2TB hard disk recorder with 4G	<b>5550</b>
	<b>MDR-508G-1000</b> - 8 channel 1TB hard disk recorder with 4G	<b>5539</b>
	<b>MDR-508W-2000</b> - 8 channel 2TB hard disk recorder with WiFi	<b>5579</b>
	<b>MDR-508W-1000</b> - 8 channel 1TB hard disk recorder with WiFi	<b>5129</b>



- 9-32Vdc
- 8 camera inputs - Supports AHD High definition cameras
- 8 trigger/alarm inputs
- Lockable and interchangeable Hard Drive Unit
- Fast, easily downloadable recordings and data
- Size (WxHxD)  
224 x 85 x 221mm  
8.8 x 3.3 x 8.7 inches
- 3 year warranty

**Main Contents**

- Mobile Digital Recorder with 2.5" SATA HDD caddy unit
- Wired Mouse
- 64Gb industrial grade Class 10 SD card
- Input / Output Cable
- Power Cable
- GPS Antenna
- 4G Antenna (G and GW models)
- Wi-Fi Antenna (W and GW models)
- USB A to B Cable (3.0)
- Security Key
- Bracket and Fixings

**Features**

- Remotely access MDR units using wireless (WiFi models only) and/or Mobile network (4G models only)
- Mobile apps for remote view (WiFi/4G models only)
- Geo-fencing (WiFi/4G models only)
- Mobile Standards: 2G/3G/4G
- Audio (cameras must have microphones)
- Robust aluminum housing
- Anti-vibration mounting allows for installation at any angle
- Built-in GPS
- Internal G-sensor and built-in buzzer
- Recordings saved to hard disk (protected by non-visible digital watermark) and in-built Mirror recording onto 64Gb SD card
- Recording modes: normal, alarm and timer (all watermarked)
- Configurable alarm trigger settings (speed, G-force, motion detection, video loss, voltage)
- Record images prior to alarm activation and after vehicle switched off

- MDR-Dashboard (full player) and MDR-Player (portable) with Google and MS Bing maps (English only)
- Search by date, time or triggered events
- Multi-level password protected access
- Hard drive unit directly pluggable to PC via USB port
- 8 x trigger Inputs, 2x trigger outputs and 1x12V power output
- Built-in HDD heater
- MDR Control using USB Mouse or optional IR remote control
- USB 3.0 connection
- TV System: PAL/NTSC/AHD
- Compatible with Brigade's vehicle CCTV camera monitor systems, IP cameras and Backeye@360 systems

**Image and Audio Quality**

- High quality H.264 image compression
- ADPCM - audio compression
- Choice of 8 low to high resolution settings
- Record at between 1 and 25 frames per second, per channel

**Power**

- Max power consumption: 80 Watts
- Current: 6.6 Amps

**Durability & Standards**

- Mechanical vibration: 1G
- Mechanical shock: 51G
- Operating temperature: -40 to +70°C / -40 to +158°F
- E-Marked: UNECE R10 compliant
- CE marked
- FCC approved
- IC approved
- RoHS2 Compliant

**OPTIONAL EXTRA**

**Expand the channel capability of the MDR with the addition of an Expansion Module and IP cameras:**

See pages 52-53

**IP-EM4 - Expansion Module adds 4 channels to MDR-508 = 12 channels**

**IP-EM8 - Expansion Module adds 8 channels to MDR-508 = 16 channels**







# Mobile Digital Recorders

**Model**

**Part No:**

## MOBILE DIGITAL RECORDER

<b>MDR-504-2000</b>	- 4 channel 2TB hard disk recorder	<b>5563</b>
<b>MDR-504-1000</b>	- 4 channel 1TB hard disk recorder	<b>5561</b>
 	<b>MDR-504GW-2000</b> - 4 channel 2TB hard disk recorder with WiFi and 4G	<b>5554</b>
	<b>MDR-504GW-1000</b> - 4 channel 1TB hard disk recorder with WiFi and 4G	<b>5552</b>
	<b>MDR-504G-2000</b> - 4 channel 2TB hard disk recorder with 4G	<b>5546</b>
	<b>MDR-504G-1000</b> - 4 channel 1TB hard disk recorder with 4G	<b>5548</b>
	<b>MDR-504W-2000</b> - 4 channel 2TB hard disk recorder with WiFi	<b>5567</b>
	<b>MDR-504W-1000</b> - 4 channel 1TB hard disk recorder with WiFi	<b>5565</b>



- 9-32Vdc
- 4 camera inputs - Supports AHD High definition cameras
- 8 trigger/alarm inputs
- Lockable and interchangeable Hard Drive Unit
- Fast, easily downloadable recordings and data
- Size (WxHxD)  
190 x 75 x 222mm  
7.5 x 3 x 8.7 inches
- 3 year warranty

### Main Contents

- Mobile Digital Recorder with 2.5" SATA HDD caddy unit
- Wired Mouse
- 32Gb industrial grade Class 10 SD card
- Input / Output Cable
- Power Cable
- GPS Antenna
- 4G Antenna (G and GW models)
- Wi-Fi Antenna (W and GW models)
- USB A to B Cable (3.0)
- Security Key
- Bracket and Fixings

### Features

- Remotely access MDR units using wireless (WiFi models only) and/or Mobile network (4G models only)
- Mobile apps for remote view (WiFi/4G models only)
- Geo-fencing (WiFi/4G models only)
- Mobile Standards: 2G/3G/4G
- Audio (cameras must have microphones)
- Robust aluminum housing
- Anti-vibration mounting allows for installation at any angle
- Built-in GPS
- Internal G-sensor and built-in buzzer
- Recordings saved to hard disk (protected by non-visible digital watermark) and in-built Mirror recording onto SD card
- Recording modes: normal, alarm and timer (all watermarked)
- Configurable alarm trigger settings (speed, G-force, motion detection, video loss, voltage)
- Record images prior to alarm activation and after vehicle switched off

- MDR-Dashboard (full player) and MDR-Player (portable) with Google and MS Bing maps (English only)
- Search by date, time or triggered events
- Multi-level password protected access
- Hard drive unit directly pluggable to PC via USB port
- 8 x trigger Inputs, 2x trigger outputs and 1x12V power output
- Built-in HDD heater
- MDR Control using USB Mouse or optional IR remote control
- USB 3.0 connection
- TV System: PAL/NTSC/AHD
- Compatible with Brigade's vehicle CCTV camera monitor systems, IP cameras and Backeye@360 systems

### Image and Audio Quality

- High quality H.264 image compression
- ADPCM - audio compression
- Choice of 8 low to high resolution settings
- Record at between 1 and 25 frames per second, per channel

### Power

- Max power consumption: 60 Watts
- Current: 5 Amps

### Durability & Standards

- Mechanical vibration: 1G
- Mechanical shock: 51G
- Operating temperature: -40 to +70°C / -40 to +158°F
- E-Marked: UNECE R10 compliant
- CE marked
- FCC approved
- IC approved
- RoHS2 Compliant

## OPTIONAL EXTRA

Expand the channel capability of the MDR with the addition of an Expansion Module and IP cameras:

See pages 52-53



**IP-EM4 - Expansion Module adds 2 channels to MDR-504 = 6 channels**

**Model** **Part No:**

**500 SERIES MOBILE DIGITAL RECORDER ACCESSORIES**

	<b>AC-305</b>	- Splitter cable connects 1 x Backeye®360 BN360-200 camera to MDR & ECU	<b>4903</b>
	<b>AC-306</b>	- Connects 1 x Select camera to MDR and monitor	<b>4904</b>
	<b>AC-307</b>	- Connects 1 x Elite camera to MDR and monitor	<b>4905</b>
	<b>MDR-RP01</b>	- Remote status & interface panel with panic button	<b>4872</b>
	<b>MDR-06RPC</b>	- 6m/19.7" cable for Remote status & interface panel	<b>4873</b>
	<b>MDR-GS-02</b>	- External G-sensor	<b>4988</b>
	<b>MDR-03GSC</b>	- 3m/9.8" G-sensor cable	<b>4874</b>
	<b>MDR-508GW-EXP-0</b>	- <b>Wi-Fi &amp; 4G upgrade Expansion Module</b> <small>For MDR-508 models only. SD card not included</small>	<b>S5542</b>
	<b>MDR-508G-EXP-0</b>	- <b>4G upgrade Expansion Module</b> <small>For MDR-508 models only. SD card not included</small>	<b>S5543</b>
	<b>MDR-508W-EXP-0</b>	- <b>Wi-Fi upgrade Expansion Module</b> <small>For MDR-508 models only. SD card not included</small>	<b>5311</b>
	<b>MDR-500-500-MCU</b>	- <b>Caddy unit with 500GB HDD</b>	<b>5132</b>
	<b>MDR-500-1000-MCU</b>	- <b>Caddy unit with 1TB HDD</b>	<b>5157</b>
	<b>MDR-500-2000-MCU</b>	- <b>Caddy unit with 2TB HDD</b>	<b>5330</b>
	<b>SD-32GB-IND</b>	- 32GB industrial grade Class 10 SD card	<b>4875</b>
	<b>SD-64GB-IND</b>	- 64GB industrial grade Class 10 SD card	<b>4876</b>
	<b>MDR-FPB32-01</b>	- <b>External SD Mirror-recorder in fireproof housing</b> <small>with 32GB industrial grade Class 10 SD card</small>	<b>4896</b>



# IP Cameras & Expansion Modules

## What are IP cameras & Expansion Modules?

An Internet Protocol (IP) camera is a high-definition digital camera with its own IP address. Instead of transmitting video over a video cable to a monitor or MDR, the IP camera transmits digital video to the MDR over a data connection (ethernet cable) where the images are saved to the HDD memory.

Brigade Expansion Modules use Power Over Network (PON) Switch technology to expand the channel capability of the MDR by transmitting digital video images from IP cameras over the top of existing analogue video cables/signals. The MDR on-screen display allows easy camera set up without need for specific IP camera knowledge

**Benefit:** Connecting IP cameras increases the number of channels available on the MDR:

MDR-504	- 4 x Analogue channels plus 1 x IP channel	= 5 channels
MDR-504 and PON switch	- 4 x Analogue channels plus 2 x IP channels	= 6 channels
MDR-508	- 8 x Analogue channels plus 1 x IP channel	= 9 channels
MDR-508 and PON switch	- 8 x Analogue channels plus up to 8 x IP channels	= 16 channels

**Model**

**Part No:**

**NEW**

**IP CAMERA**



**IP-1000C - Internal forward-facing camera**

**5935**

• **Viewing angle (HxVxD)**  
87 x 48 x 95°

• **IP20**

• **Size (WxHxD)**  
75 x 122 x 40mm  
3 x 5 x 1.6 inches

• **3 year warranty**



**Features**

- High-definition picture quality
- Windscreen flush-mounted to avoid reflections
- Microphone
- Normal view - mirror view via OSD settings or IP web interface
- Backlight compensation
- Automatic white balance
- Supports web browser access
- Fast setup feature in MDR 500 series to auto-assign camera IP address
- Picture Elements: 1920(H) x 1080(V)
- Imaging device: CMOS
- TV Lines: 800

**Power**

- Power consumption: 2.5 Watts
- Current: 0.2 Amps

**Durability & Standards**

- Mechanical vibration: 4.7G
- Mechanical shock: 51G
- Operating temperature: -40 to +70°C / -40 to +158°F
- Video output signal: H264 or H.265
- Network protocol: MDR5, ONVIF, TCP/IP, HTTP, DHCP, NTP, FTP
- CE marked
- E-Marked: UNECE R10 compliant
- FCC approved
- IC approved

**Note:** For use with MDR only

**NEW**

**IP CAMERA**



**IP-1200C - Surface-mount dome camera**

**5937**

• **Viewing angle (HxVxD)**  
94 x 53 x 95°

• **IP65**

• **Size (WxHxD)**  
102 x 55 x 96 mm  
4 x 2 x 3.8 inches

• **3 year warranty**



**Features**

- High-definition picture quality
- Surface mount
- Heater
- Normal view
- Backlight compensation
- Automatic white balance
- Supports web browser access
- Fast setup feature in MDR 500 series to auto-assign camera IP address
- Picture Elements: 1920(H) x 1080(V)
- Imaging device: CMOS
- TV Lines: 700

**Power**

- Power consumption: 3.5 Watts
- Current: 0.3 Amps

**Durability & Standards**

- Mechanical vibration: 4.7G
- Mechanical shock: 51G
- Operating temperature: -40 to +70°C / -40 to +158°F
- Video output signal: H264 or H.265
- Network protocol: MDR5, ONVIF, TCP/IP, HTTP, DHCP, NTP, FTP
- CE marked
- E-Marked: UNECE R10 compliant
- FCC approved
- IC approved

**Note:** For use with MDR only

**Model**
**Part No:**
**NEW IP CAMERA**
**IP-1100C - Surface-mount camera**
**5936**

- **Viewing angle (HxVxD)**  
84 x 46 x 103°
- **IP67**
- **Size (WxHxD)**  
96 x 52 x 58mm  
3.8 x 2 x 2.3 inches
- **3 year warranty**

**Features**

- High-definition picture quality
- Surface mount
- Built-in G-sensor for automatic image orientation
- High power infrared LED for low-light performance
- Day/night sensor
- Normal view
- Backlight compensation
- Automatic white balance
- Supports web browser access
- Fast setup feature in MDR 500 series to auto-assign camera IP address
- Imaging device: CMOS
- Picture elements: 1920 x 1080
- TV Lines: 800

**Power**

- Power consumption: 5 Watts
- Current: 0.2 Amps

**Durability & Standards**

- Mechanical vibration: 8.5G
- Mechanical shock: 51G
- Operating temperature: -40 to +70°C / -40 to +158°F
- Video output signal: H.264 or H.265
- Network protocol: MDR5, ONVIF, TCP/IP, HTTP, DHCP, NTP, FTP
- CE marked
- E-Marked: UNECE R10 compliant
- FCC approved
- IC approved

**Note:** For use with MDR only

**NEW IP EXPANSION MODULES**
**IP-EM4 - PON 4-channel switch**
**5860**
**IP-EM8 - PON 8-channel switch**
**5861**

- **12-24Vdc**
- **4 or 8 IP camera inputs**
- **Size (WxHxD)**  
**IP-EM4: 149 x 44 x 127mm**  
6 x 1.7 x 5 inches  
**IP-EM8: 174 x 54 x 129.5mm**  
7 x 2 x 5 inches
- **3 year warranty**

**Features**

- Expands the channel capability of the MDR by enabling the addition of IP cameras:  
IP-EM4 - adds 2 channels to MDR-504  
IP-EM4 - adds 4 channels to MDR-508  
IP-EM8 - adds 8 channels to MDR-508  
IP-EM8 not compatible with MDR-504

**Power**

- Power consumption: 3 Watts

**Durability & Standards**

- Mechanical vibration: 2.3G
- Mechanical shock: 150G
- Operating temperature: -40 to +70°C / -40 to +158°F
- CE marked
- E-Marked: UNECE R10 compliant
- FCC approved
- IC approved

**NEW IP CAMERA ACCESSORIES**
**IP-EC-1 - CAT5E Ethernet cable 1m / 3.3'**
**5865**
**IP-EC-5 - CAT5E Ethernet cable 5m / 16'**
**5866**
**IP-EM-PC - MDR-PON Power cable**
**5864**
**IP-L601 - IP Camera extension cable 1m / 3.3'**
**5867**
**IP-L603 - IP Camera extension cable 3m / 10'**
**5902**
**IP-L605 - IP Camera extension cable 5m / 16'**
**5903**
**IP-L610 - IP Camera extension cable 10m / 33'**
**5982**
**IP-L615 - IP Camera extension cable 15m / 49'**
**5904**
**IP-L620 - IP Camera extension cable 20m / 66'**
**5983**
**IP-L630 - IP Camera extension cable 30m / 98'**
**5984**
**IP-1XXX-PC - IP Power and Ethernet cable -**
**5985**

To connect a single camera to an MDR without the PON Switch



**WARNING:** There is a latency (time lag) in all digital video transmission, including IP Cameras. Although this time lag is small (~800ms), it is unacceptable for a camera that a driver is using as a safety and manoeuvring aid. Brigade IP cameras are an excellent choice for general monitoring (eg bus interior, doors, luggage compartment) and recording purposes, but should not be used as a driver aid for manoeuvring or blind-spot monitoring. Analogue cameras are still the best choice for safety critical manoeuvring and blind spot monitoring applications.





# Ultrasonic Object Detection Systems

## Sensor Systems

Reducing blind spots and improving driver visibility are important issues for operators of road-going vehicles. Brigade's ultrasonic detection sensors minimize both vehicle damage and collisions with pedestrians, cyclists or objects. Perfect for road-going commercial vehicles operating in confined spaces or maneuvering at low speed.

The detection system alerts the driver of objects close to the vehicle, whether moving or stationary. An in-cab warning informs of distance while an optional external speaking alarm can be added to alert cyclists and pedestrians that the vehicle is turning.

## On-Screen Display

Working in conjunction with a camera monitor system and up to two ultrasonic detection systems, the on-screen display module warns the driver of obstacles close to the vehicle by overlaying 3-stage audible and visual ultrasonic data onto the camera image on the vehicle's monitor.

- **Integration of Brigade's ultrasonic obstacle detection systems and camera monitor systems**
- **Ultrasonic detection warnings overlaid onto camera image on in-cab monitor**
- **Reduced driver stress and distractions as all information is in one view**

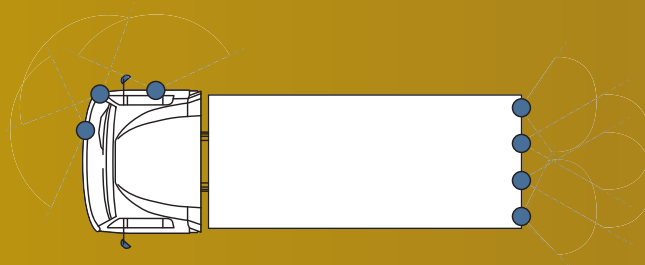
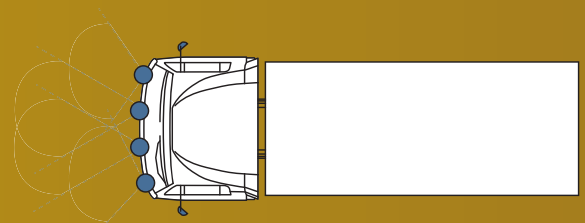
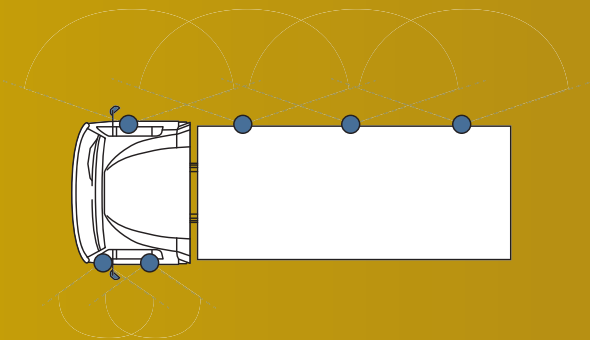



# Ultrasonic Object Detection

## Ultrasonic Detection On-Screen Display Module



- Integration of Brigade's ultrasonic obstacle detection systems and Backeye® camera monitor systems
- Ultrasonic detection warnings overlaid onto camera image on in-cab monitor
- Reduced driver stress and distractions as all information is in one view

### Sensor data and camera image combined

Brigade's ultrasonic proximity sensors minimize both vehicle damage and collisions with pedestrians, cyclists or objects. Perfect for road-going commercial vehicles operating in confined spaces or maneuvering at low speed.

Working in conjunction with a Backeye® camera monitor system and up to two ultrasonic detection systems, the on-screen display module warns the driver of obstacles close to the vehicle by overlaying 3-stage audible and visual ultrasonic data onto the camera image on the monitor.

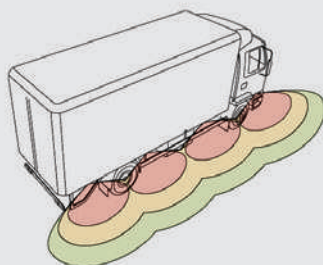

**Model**

**Part No:**

## ULTRASONIC ON-SCREEN DISPLAY MODULE

UDS-OSD21-ECU - On-screen display module NTSC

5347



- Allows 3-stage audible and visual Ultrasonic data to be overlaid onto camera image on vehicle monitor
- 12-24Vdc
- 2 camera inputs
- 2 trigger inputs
- 2 UDS inputs
- 2 UDS outputs
- 2 year warranty

### Contents

- OSD ECU
- Power cable
- Splitter cable
- Trigger cable

### Features

- Overlay on monitor of vehicle icon and detection data from up to 2 x ultrasonic detection systems
- Compatible with 1x Sidescan® Frontscan® and Backscan®
- UDS overlay will appear on a black background if no cameras installed
- Graphics can be overlaid left or right on the monitor
- Audible warning via monitor
- Ultrasonic system fault displayed on monitor
- Compatible with MDR

### Power

- Power consumption: 1.7 Watts
- Current: 140mA

### Durability & Standards

- Mechanical vibration: 5G
- Mechanical shock: 10G
- Operating temperature: -30 to +70°C +22 to +158°F
- IP30
- Dimensions (WxDxH): 74 x 118 x 28 mm 2.9 x 4.6 x 1.1 inches
- CE marked
- E-Marked: UNECE R10 compliant
- FCC Approved
- IC Approved

**Note: Not compatible with HD camera monitor systems**

**Model**

**Part No:**

**BACKSCAN® ULTRASONIC DETECTION SYSTEM**

**BS-4000W - Backscan® Rear reversing sensor system**

**3744**



- 4 sensor system
- 12-24Vdc
- 2.5m detection range - outer sensors 2.5m/0.6m (8.2/2') (selectable via dip switch)
- Graduated visual and audible distance warning display
- Underslung and flush-mount fixings included
- 50cm/1.2' compensation range for sensors fitted inboard of vehicle rear (selectable via dip switch)
- 3 year warranty

**Contents**

- 4 x sensors
- Visual and audible display
- 4 x 0° flush mount fixings
- 4 x 11° flush mount fixings
- 4 x underslung fixings
- Waterproof control box
- 15m/49' display cable
- 4 x 2.5m/8' sensor cables

**Features**

- Obstacles detected in under 200 milliseconds
- Environment Learning Mode prevents false alarms from tow-hooks and other ancillary equipment that intrudes in the first 100cm (3.3') of the detection zone
- Self-diagnostic function
- 1 x Trigger output

**Power**

- Power consumption: 2.4 Watts
- Current: 200mA

**Durability & Standards**

- Mechanical vibration: 5G
- Mechanical shock: 10G
- Operating temperature: -30 to +80°C / -22 to +176°C
- Waterproof sensors to IP68
- Waterproof control box to IP69K
- CE marked
- E-Marked: UNECE R10 compliant
- FCC approved



**ADDITIONS FOR ARTICULATED VEHICLES**

SK-15-04	Truck/trailer camera/sensor cable kit	3997
SK-UDS-05	Truck/trailer sensor only cable kit	4219
UDS-10BC	10m/33' Buzzer/display cable	3716

**OPTIONAL EXTRA**

UDS-RELAY-24	Trigger-out diode protected relay 24Vdc	4215
UDS-RELAY-12	Trigger-out diode protected relay 12Vdc To power a device switched by the output trigger	4216

# Ultrasonic Object Detection

## Sidescan®Flex

### Flexible side detection

Sidescan®Flex is a four-sensor system fitted to the side of a vehicle to detect objects in the nearside blind spot, where cyclists or pedestrians can otherwise go undetected.

An advancement to the standard Sidescan® system, Sidescan®Flex allows the operator to choose from four detection configurations, each with different detection distances and audible and visual alerts (see table).

Sidescan® Flex has an increased maximum detection range of 2.5 metres / 8.2 feet.

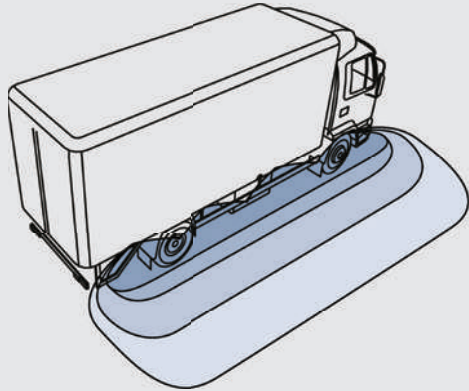

Detection distance		Config 1	Config 2	Config 3	Config 4
0 - 0.6m 0 - 2'	Beeps per second	Constant	Constant	Constant	Constant
	Flashes per second	8	8	8	8
0.6 - 0.9m 2 - 3'	Beeps per second	Constant	4	4	4
	Flashes per second	8	8	8	8
0.9 - 1.5m 3 - 4.9'	Beeps per second	4	-	-	1
	Flashes per second	4	4	4	4
1.5 - 2.5m 4.9 - 8.2'	Beeps per second	1	-	-	-
	Flashes per second	1	1	-	-

**Model**

**Part No:**

**NEW**

## SIDESCAN®FLEX ULTRASONIC DETECTION SYSTEM

**SS-4200W - Sidescan®Flex sensor system with mute function**

**5916**

**SS-4200W-000 - Sidescan®Flex sensor system with mute function, low speed trigger module and turn indicator sensor kit**

**6075**

Includes LS-60-A low speed trigger module and TS-001ECU turn indicator sensor



- 4 sensor system
- 12-24Vdc
- Detection zones - 0 - 2.5m (0 - 8.2') (4 audible/visual configurations, selectable via dip switches)
- Underslung and flush-mount fixings included
- 1 Output trigger
- 3 year warranty

### Contents

- 4 x sensors
- Buzzer
- 4 x 0° flush mount fixings
- 4 x 11° flush mount fixings
- 4 x underslung fixings
- Waterproof control box
- 10m/33' buzzer cable
- 4 x 4.5m/15' sensor cables
- 2 x 2.5m/8' extension cables

### Features

- Obstacles detected in under 200 milliseconds
- Buzzer with audible distance warning, LED & adjustable volume control
- Buzzer will silence after 4 seconds if there is no movement from detected object or vehicle
- Self-diagnostic function

- Environment Learning Mode prevents false alarms from ancillary equipment that intrudes in the first 100cm (3.3') of the detection zone

### Durability & Standards

- Mechanical vibration: 5G
- Mechanical shock: 10G
- Operating temperature: -30 to +80°C / -22 to +176°C
- Waterproof sensors to IP68
- Waterproof control box to IP69K
- CE marked
- E-Marked: UNECE R10 compliant
- FCC approved

### Power

- Power consumption: 2.4 Watts
- Current: 200mA

## OPTIONAL EXTRA



**UDS-RELAY-24 Trigger-out diode protected relay 24Vdc**

**4215**

**UDS-RELAY-12 Trigger-out diode protected relay 12Vdc**

**4216**

To power a device switched by the output trigger

**Model**

**Part No:**

**SIDESCAN® ULTRASONIC DETECTION SYSTEM**

<b>SS-4100W -</b>	<b>Sidescan® Side sensor system with mute function</b>	<b>5257</b>
<b>SS-4100W-000 -</b>	<b>Sidescan® Side sensor system with mute function, low speed trigger module and turn indicator sensor kit</b>	<b>5344</b>
Includes LS-60-A low speed trigger module and TS-001ECU turn indicator sensor		



- 4 sensor system
- 12-24Vdc
- 1.0/1.5m (3.2/4.9') detection range - (selectable via dip switch)
- Audible distance warning
- Underslung and flush-mount fixings included
- 2 levels of sensitivity - (selectable via dip switch)
- 3 year warranty

**Contents**

- 4 x sensors
- Buzzer
- 4 x 0° flush mount fixings
- 4 x 11° flush mount fixings
- 4 x underslung fixings
- Waterproof control box
- 10m/33' buzzer cable
- 4 x 4.5m/14.7' sensor cables
- 2 x 2.5m/8.2' extension cables

**Features**

- Obstacles detected in under 200 milliseconds
- Buzzer with audible distance warning, LED & adjustable volume control
- Buzzer will silence after 4 seconds if there is no movement from detected object or vehicle
- Environment Learning Mode prevents false alarms from ancillary equipment that intrudes in the first 100cm of the detection zone
- Self-diagnostic function

**Durability & Standards**

- Mechanical vibration: 5G
- Mechanical shock: 10G
- Operating temperature: -30 to +80°C/ -22 to +176°C
- Waterproof sensors to IP68
- Waterproof control box to IP69K
- CE marked
- E-Marked: UNECE R10 compliant
- FCC approved

**Power**

- Power consumption: 2.4 Watts
- Current: 200mA



**SIDESCAN®/SIDESCAN®FLEX ADDITIONS FOR ARTICULATED VEHICLES**

<b>SK-15-04</b>	<b>Truck/trailer camera/sensor cable kit</b>	<b>3997</b>
<b>SK-UDS-05</b>	<b>Truck/trailer sensor only cable kit (required)</b>	<b>4219</b>
<b>UDS-10BC</b>	<b>10m/33' display cable (required)</b>	<b>3716</b>
<b>SS-4100W</b>	<b>Additional Sidescan sensor system for cab (optional)</b>	<b>5257</b>

**SIDESCAN®/SIDESCAN®FLEX RECOMMENDED EXTRAS**

<b>LS-60-A</b>	<b>Low speed trigger module</b> Enables sensors below designated speed	<b>4851</b>
<b>TS-001ECU</b>	<b>Turn indicator trigger for system activation</b>	<b>1362</b>

**SIDESCAN®/SIDESCAN®FLEX OPTIONAL EXTRA**

<b>SS-BC-08</b>	<b>Backchat speaking alarm with side turn warning for cyclists/pedestrians</b> Note: TS-001ECU Turn indicator trigger is required	<b>1334</b>
<b>TCO-47-01</b>	<b>Latched auto-reset Backalarm cut-out (dash mount)</b>	<b>4752</b>





# Ultrasonic Object Detection

Model

Part No:

## FRONTSCAN® ULTRASONIC DETECTION SYSTEM

FS-4000W - Frontscan® Front sensor system

3747



- 4 sensor system
- 12-24Vdc
- 2.0m/1.0m (6.8'/3.2') detection range - outer sensors can be reduced to 0.6m (2') (selectable via dip switches)
- Audible distance warning
- Flush-mount
- 3 year warranty

### Contents

- 4 x sensors
- Buzzer
- 4 x 11° flush mount fixings
- 4 x 18° flush mount fixings
- 4 x 26° flush mount fixings
- Waterproof control box
- 2.5m/8' buzzer cable
- 4 x 2.5m/8' sensor cables

### Features

- Obstacles detected in under 200 milliseconds
- Environment Learning Mode prevents false alarms from tow-hooks and other ancillary equipment that intrudes in the first 100cm

- (3.3') of the detection zone
- Self-diagnostic function
- 1 x Trigger output

### Durability & Standards

- Operating temperature: -30 to +80°C / -22 to +176°F
- Waterproof sensors to IP68
- Waterproof control box to IP69K
- CE marked
- E-Marked: UNECE R10 compliant

### Power

- Power consumption: 2.4 Watts
- Current: 200mA

## RECOMMENDED EXTRA



LS-60-A

**Low speed trigger module**

Enables sensors below designated speed

4851

## OPTIONAL EXTRA



UDS-RELAY-24

**Trigger-out diode protected relay 24Vdc**

4215

UDS-RELAY-12

**Trigger-out diode protected relay 12Vdc**

4216

To power a device switched by the output trigger

## CORNERSCAN® ULTRASONIC DETECTION SYSTEM

CS-3100 - Cornerscan® Corner sensor system with mute function

5261



- 3 sensor system
- 12-24Vdc
- 0.6/1.0m (2'/4') detection range - (selectable via dip switch)
- Audible distance warning
- Flush-mount
- 2 levels of sensitivity - (selectable via dip switch)
- 3 year warranty

### Contents

- 3 x sensors
- Buzzer
- 3 x 11° flush mount fixings
- 3 x 18° flush mount fixings
- 3 x 26° flush mount fixings
- Waterproof control box
- 2.5m/8' buzzer cable
- 3 x 2.5m/8' sensor cables

### Features

- Obstacles detected in under 200 milliseconds
- Buzzer with audible distance warning, LED & adjustable volume control
- Buzzer will silence after 4 seconds if there is no movement from detected object or vehicle
- Environment Learning Mode prevents false alarms from

- ancillary equipment within the first 100cm (3.3') of the detection zone
- Self-diagnostic function

### Power

- Power consumption: 2.4 Watts
- Current: 2 Amps

### Durability & Standards

- Mechanical vibration: 5G
- Mechanical shock: 10G
- Operating temperature: -30 to +80°C / -22 to +176°F
- Waterproof sensors to IP68
- Waterproof control box to IP69K
- CE marked
- E-Marked: UNECE R10 compliant
- FCC approved

## RECOMMENDED EXTRA



LS-60-A

**Low speed trigger module**

Enables sensors below designated speed

4851

**Model**

**Part No:**

**STEPSCAN™ ULTRASONIC DETECTION SYSTEM**

<b>ST-2100 -</b>	<b>Stepscan™ Step sensor system with mute function</b>	<b>5262</b>
<b>ST-2100-60-A -</b>	<b>Stepscan™ Step sensor system with mute function and low speed trigger module</b>	<b>5345</b>
	<small>Includes UDS-4.5SC 4.5m/14.7' extension cable</small>	



- 2 sensor system
- 12-24Vdc
- 0.6/1.0m (2/3.2') detection range - (selectable via dip switch)
- Audible distance warning
- Flush-mount
- 2 levels of sensitivity - (selectable via dip switch)
- 3 year warranty

**Contents**

- 2 x sensors
- Buzzer
- 2 x 11° flush mount fixings
- 2 x 18° flush mount fixings
- 2 x 26° flush mount fixings
- Waterproof control box
- 2.5m/8.2' buzzer cable
- 2 x 2.5m/8.2' sensor cables

**Features**

- Obstacles detected in under 200 milliseconds
- Buzzer with audible distance warning, LED & adjustable volume control
- Buzzer will silence after 4 seconds if there is no movement from detected object or vehicle
- Environment Learning Mode prevents false alarms from

ancillary equipment that intrudes in the first 100cm (3.3') of the detection zone

- Self-diagnostic function

**Durability & Standards**

- Mechanical vibration: 5G
- Mechanical shock: 10G
- Operating temperature: -30 to +80°C / -22 to +176°C
- Waterproof sensors to IP68
- Waterproof control box to IP69K
- CE marked
- E-Marked: UNECE R10 compliant
- FCC approved

**Power**

- Power consumption: 2.4 Watts
- Current: 200mA



**RECOMMENDED EXTRA**

<b>LS-60-A</b>	<b>Low speed trigger module</b> <small>Enables sensors below designated speed</small>	<b>4851</b>
----------------	--	-------------

**EXTENSION CABLES**



<b>UDS-2.5BC - Buzzer/display extension cable 2.5m/8.2'</b>	<b>3717</b>
<b>UDS-10BC - Buzzer/display extension cable 10m/33'</b>	<b>3716</b>
<b>UDS-15BC - Buzzer/display extension cable 15m/49'</b>	<b>3746</b>
<b>UDS-2.5SC - Sensor extension cable 2.5m/8.2'</b>	<b>3719</b>
<b>UDS-4.5SC - Sensor extension cable 4.5m/14.7'</b>	<b>3720</b>
<b>UDS-7.0SC - Sensor extension cable 7.0m/23'</b>	<b>5623</b>





# Backsense®

# Radar Object Detection Systems

## FMCW technology

Backsense® heavy-duty radar sensor systems are designed for heavy-duty machines to detect people and objects in blind spots. They detect stationary and moving objects, providing the driver with in-cab visual and audible warnings – alerting the operator whose attention cannot be focused on all danger areas.

Backsense® radar uses Frequency Modulated Continuous Wave (FMCW) technology, transmitting a continuously varying radar frequency signal with unique time stamps to each instance of the wave. The time of the returning wave is referenced to the stamp without the radar needing to pause transmitting. This gives more accurate detection than alternative radar products using Pulsed Radar technology that transmit a burst of radar and listen for the returning wave.

## Radar Models

- **Backsense®** systems are available with fixed and programmable detection ranges and a programmable model with an IP69K in-cab display. Custom detection areas can be programmed to calibrate-out fixed objects or bodywork.
- **Backsense® Network radar** allows you to link up to eight radar sensors. The system provides object detection in CAN message format which may be processed to display data on control panels/displays on the vehicle or used to control aspects of the machine.
- **Backsense® on-screen display** works in conjunction with Backeye® camera monitor systems and up to two radar sensors. It warns the driver of objects in the danger zone by overlaying 5-stage audible and visual radar data onto the camera image on the monitor.

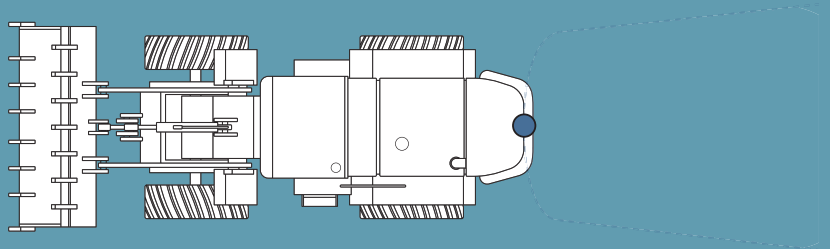



# Backsense® Radar Object Detection

Model

Part No:

**NEW**

## IP69K PROGRAMMABLE BACKSENSE® OBJECT DETECTION SYSTEM

**BS-9000-WD - Waterproof display - Programmable detection range**

**5713**



- 9-32Vdc
- **Detection length: up to 30m/98' (minimum programmable distance 0 - 3m / 0 - 9.8')**
- **Detection width: 2 to 10m / 6.6 to 33'**
- **Rugged design for harsh environmental conditions**
- **Sensor size (WxHxD) 217 x 129 x 50mm 8.5 x 5 x 1.9 inches**
- **Display size without bracket (WxHxD) 118 x 97 x 55 mm 4.6 x 3.8 x 2.2 inches**
- **IP69K sensor**
- **IP69K display**
- **3 year warranty**

### Contents

- 1 x BS-9000 Radar sensor
- 1 x IP69K audible and visual display with mounting bracket
- 1 x Extension cable 9m/29.5'
- 1 x Network Y Cable
- 1 x Network terminator
- 1 x Mini USB cable

### Features

- Frequency modulated continuous wave (FMCW) radar technology
- Effectively detects stationary, moving and multiple objects
- 1 activation input
- 1 trigger output
- 2nd trigger output for optional external alarm
- Programmable:
  - Detection area
  - Blind zones - system ignores fixed objects
  - Trigger activation
  - Buzzer
- 5 stage audible and visual distance warning display
- 3 set volume levels (maximum 95dB) with volume lock

- AMPS hole pattern for alternative mounting with industry-standard bracket
- Resistant to water, moisture, dust, vibration, heat, cold, mud and glare

### Power

- Current: 0.9 Amps
- Power consumption: 8 Watts

### Durability & Standards

- Mechanical shock- sensor: 100G
- Mechanical shock- display: 50G
- Mechanical vibration: 8.3G
- Operating temperature: -40 to +85°C / -40 to +185°F
- CE marked
- E-Marked: UNECE R10 compliant
- BS EN 13309: 2010
- ISO13766: 2006

### Configuration Software

- \*Available via Brigade website or USB (purchased separately)

## OPTIONAL EXTRAS

**CT-470 - Constant tone external alarm - 102dB**

**1346**

**\*BS-WD-USB - USB -programming software, port driver and operating guide**

**5637**

## PROGRAMMABLE BACKSENSE® OBJECT DETECTION SYSTEM

**BS-8000 - Standard display - Programmable detection range**

**4530**



- 9-32Vdc
- **Detection length: up to 30m/98' (minimum programmable distance 0 - 3m / 0 - 9.8')**
- **Detection width: 2 to 10m/ 6.5 to 33'**
- **Rugged design for harsh environmental conditions**
- **Sensor size (WxHxD) 217 x 129 x 50mm 8.5 x 5 x 1.9 inches**
- **Display size with bracket (WxHxD) 101 x 71 x 70mm / 4 x 2.8 x 2.7"**
- **IP69K sensor**
- **3 year warranty**

### Contents

- 1 x Configurable radar sensor
- 1 x Audible and visual display with USB socket and mounting bracket
- 1 x 9m/29.5' extension cable
- 1 x Mini USB cable
- 1 x Software CD

### Features

- Frequency modulated continuous wave (FMCW) radar technology
- Effectively detects stationary, moving and multiple objects
- 1 activation input
- 1 trigger output
- Programmable:
  - Detection area
  - Blind zones - system ignores fixed objects
  - Trigger activation
  - Buzzer
- 5 stage adjustable audible and visual distance warning display
- Sensor resistant to water, moisture, dust, vibration, heat, cold, mud and glare

### Power

- Current: 0.8 Amps
- Power consumption: 8 Watts

### Durability & Standards

- Mechanical shock: 100G
- Mechanical vibration: 8.3G
- Operating temperature: -40 to +85°C / -40 to +185°F
- CE marked
- E-Marked: UNECE R10 compliant
- BS EN 13309: 2010
- ISO13766: 2006

**Model**

**Part No:**

**FIXED BACKSENSE® OBJECT DETECTION SYSTEMS**



BS-7030 - Standard display - 3m/10' length x 2.5m/8' width detection range	4527
BS-7045 - Standard display - 4.5m/14.8' length x 3.5m/11' width detection range	4528
BS-7060 - Standard display - 6m/20' length x 4.5m/14.8' width detection range	4529

- 9-32Vdc
- Maximum detection range of either 3m, 4.5m or 6m (9.8', 14.8' or 20')
- Rugged design for harsh environmental conditions
- Sensor size (WxHxD) 217 x 129 x 50mm 8.5 x 5 x 1.9 inches
- Display size with bracket (WxHxD) 101 x 71 x 70mm / 4 x 2.8 x 2.7"
- IP69K sensor
- 3 year warranty

**Contents**

- 1 x Non-configurable radar sensor
- 1 x Standard audible and visual display with mounting bracket
- 1 x 9m/29.5' extension cable

**Features**

- Frequency modulated continuous wave (FMCW) radar technology
- Effectively detects stationary, moving and multiple objects
- 1 activation input
- 1 trigger output
- 5 stage adjustable audible and visual distance warning display
- Sensor resistant to water, moisture, dust, vibration, heat, cold, mud and glare

**Power**

- Current: 0.8 Amps
- Power consumption: 8 Watts

**Durability & Standards**

- Mechanical shock: 100G
- Mechanical vibration: 8.3G
- Operating temperature: -40 to +85°C / -40 to +185°F
- CE marked
- E-Marked: UNECE R10 compliant
- BS EN 13309: 2010
- ISO13766: 2006

**BACKSENSE® RADAR OBJECT DETECTION ACCESSORIES**



BS-02DCX - 2m/6.6' extension cable	5272
BS-05DCX - 5m/16' extension cable	4550
BS-09DCX - 9m/30' extension cable	4551
BS-25DCSX - 25m/82' extension cable (Female end connector supplied loose)	4975
BS-00NYC - Network Y Cable for 9000 series radar	5270
BS-02PIC - Network power input cable for 9000 series radar	5271
BS-00NT - 120 Ohms Network Terminator for 9000 series radar	5291
BKT-017 - Adjustable radar bracket with 105mm/4.1" depth bracket mounting arms	4676
BKT-018 - Low-profile adjustable radar bracket	4758

# Backsense® Radar Object Detection

## Backsense® Radar On-Screen Display

- Integration of Brigade's Backsense® radar detection and Backeye® camera monitor systems
- Up to 2 Radar detection warnings overlaid onto camera image on in-cab monitor
- Reduced driver stress and distractions as all information is in one place



### Radar sensor data and camera image combined

Working in conjunction with a Backeye® camera monitor system and up to two Backsense® Network radar detection systems, the on-screen display module warns the driver of obstacles in the danger zone by overlaying 5-stage audible and visual radar data onto the camera image on the monitor.

### Model

### Part No:

## BACKSENSE® RADAR ON-SCREEN DISPLAY KIT

BS-9001-OSD - Radar sensor & On-screen display module

5658



- Allows 5-stage audible and visual radar data to be overlaid onto camera images on in-cab monitor
- 12-24Vdc
- Detection length: up to 30m/ 98' (minimum programmable distance 3m/9.8')
- Detection width: 2 to 10m/ 6.5 to 33'
- Sensor size (WxHxD)  
217 x 129 x 50mm  
8.5 x 5 x 1.9 inches
- OSD ECU size (WxHxD)  
195 x 120 x 35mm  
7.7 x 4.7 x 1.4 inches
- 2 camera inputs
- 2 BS-9000 Backsense® inputs
- 3 trigger inputs
- 3 trigger outputs
- 3 year warranty

#### Contents

- 1 x OSD Radar ECU
- 1 x BS-9000 Radar sensor
- 1 x Network power cable
- 1 x Extension cable 9m/29.5'
- 3 x Network Y-cable
- 2 x Network terminator

#### Features

- Frequency modulated continuous wave (FMCW) radar technology
- Overlay on monitor of detection data from up to 2 BS-9000 radar sensors
- Each radar can be shown in one of 8 positions around the monitor/vehicle
- Compatible with Backsense® BS-9000 Network radar sensors only
- Programmable:
  - Detection area
  - Blind zones - system ignores fixed objects
  - Overlay transparency level
- Radar system fault displayed on monitor
- USB connection for configuration via PC
- Compatible with MDR, non-HD Backeye®360 & Elite range camera monitor systems (Select range via adapters)
- Audible warning via monitor or optional internal buzzer
- Supports external warning alarm

#### Durability & Standards

- Operating temperature: -40 to +85°C / -40 to +185°F
- OSD: IP30
- CE marked
- E-Marked: UNECE R10 compliant
- FCC Approved
- IC Approved

#### Configuration Software

- \*Available via Brigade website or USB (purchased separately)

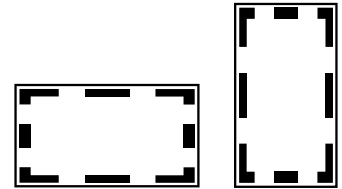

To not obstruct camera views, each radar can be shown in one of eight positions around the edge of the monitor

Camera monitor system not included

### TO ADD AN ADDITIONAL RADAR SENSOR:

1 x BS-9000 - Network Radar sensor	5266
1 x BS-00NYC - Network Y Cable	5270
1 x Extension cable	

### OPTIONAL EXTRAS

*BS-9001-USB- USB - programming software, port driver and operating guide	5656
AC-007 - Adapter cable to connect a Select range monitor	1984
AC-020 - Adapter cable to connect a Select range camera	2590

# Backsense® CAN Radar

For OEM and specialist application markets, Brigade's Network Radar allows you to connect and link up to 8 sensors to cover large, sometimes complex blind spot zones around a vehicle or machine.

The system provides object detection in CAN (Controller Area Network) message format which may be processed to display data on control panels/displays on the vehicle or used to interact with aspects of the machine.

Each connected radar sensor is allocated a unique ID and will transmit data for up to 8 closest objects. With a detection range of up to 30m/98' length and 10m/33' width, it provides a flexible system to meet customer specific requirements.

- Provides object detection in CAN message format
- Independent CAN Bus may communicate with existing CAN network via CAN Gateway
- Separate CAN message & ID for each object detected (up to 8 per sensor)

## Model

## Part No:

### NETWORK BACKSENSE® OBJECT DETECTION

BS-9000 - Backsense® CAN object detection radar

5266



- 12-24 Vdc
- Detection length: up to 30m/98'
- Detection width: up to 10m/33'
- Sensor size (WxHxD)  
217 x 129 x 50mm  
8.5 x 5 x 1.9 inches
- IP69K sensor
- 3 year warranty

#### Contents

- 1 x BS-9000 Radar sensor

#### Features

- Frequency modulated continuous wave (FMCW) radar technology
- Network up to 8 sensors
- Extremely rugged design for severe weather conditions and all terrains
- Communication via CAN Gateway
- Configurable CAN ID
- Complies with CAN2.0A Base Frame Format
- Separate CAN message & ID for each object detected (up to 8 closest objects per sensor)

#### Power

- Current: 0.4 Amps
- Power consumption; 4 Watts

#### Durability & Standards

- Mechanical shock: 100G
- Operating temperature: -40 to +85°C / -40 to +185°F
- CE marked
- E-Marked: UNECE R10 compliant
- BS EN 13309: 2010
- ISO13766: 2006

**Note: For CAN message format, refer to user manual at [brigade-electronics.com](http://brigade-electronics.com)**





# Warning Alarms & Quiet Vehicle Sounder

## Warning and Back Up Alarms

Vital safety devices needed to warn workers and pedestrians that a vehicle is maneuvering.

**bbs-tek® white sound®** are the safest alarms in the world due to their instant locatability and directional sound. The multi-frequency alarms are only heard in the danger zone, thus eliminating noise nuisance for local residents. bbs-tek® alarms are endorsed by PIEK and the Noise Abatement Society and have been awarded the Quiet Mark.



**bbs-tek® White Sound® Smart alarms** auto-adjust to 5-10dB above ambient.

### Heavy duty

For quarry and construction machines or environments with high ambient noise.

### Medium duty

Ideal for commercial road going vehicles and environments with mid-level ambient noise.

## Quiet Vehicle Sounder

Designed for electric and hybrid-electric vehicles of all types, the QVS Electric Vehicle Sounder warns pedestrians and other vulnerable road users that a quiet vehicle is approaching.

Front speaker system incorporating bbs-tek® patented technology for instantly locatable and directional sound. Pitch and volume increase with vehicle speed in a similar way as an internal combustion engine. Sound cuts out above a pre-set speed threshold.

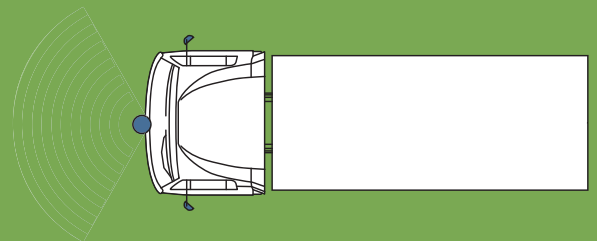
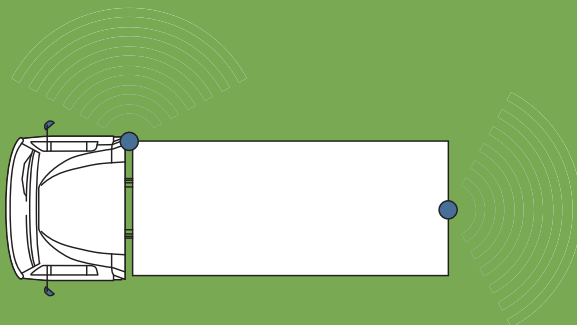

# bbs-tek® White Sound® Alarms

Model

Part No:

## WHITE SOUND® SMART BACK UP ALARM

SA-BBS-107 - Self-adjusting heavy-duty - 87-107 Decibels

1400



- 12-24Vdc
- IP68
- Size (WxHxD)  
172 x 79 x 95mm  
6.7 x 3.1 x 3.7 inches
- Lifetime warranty

### Features

- Alarm continually adjusts to 5-10dB above ambient
- Multi-frequency broadband sound
- Instantly locatable
- Sound confined to danger area
- Eliminates noise nuisance
- Sounder unit: Driver
- Hole centers: 153mm / 6"

### Power

- Current: Max 1 Amp

### Durability & standards

- Mechanical vibration: 10G
- Operating temperature: -40 to +85°C / -40 to +185°F
- CE marked
- E-Marked: UNECE R10 compliant
- SAE J994

## WHITE SOUND® SMART BACK UP ALARM

SA-BBS-97 - Self adjusting - medium duty - 77-97 Decibels

1399

SA-BBS-97HV - Self adjusting - electric forklift - 77-97 Decibels

1398



- 12-24Vdc
- 36-80Vdc (HV)
- IP68
- Size (WxHxD)  
127 x 76 x 65mm  
5 x 3 x 2.5 inches
- Lifetime warranty

### Features

- Alarm continually adjusts to 5-10dB above ambient
- Multi-frequency white sound alarm
- Instantly locatable
- Sound confined to danger area
- Eliminates noise nuisance
- Sounder unit: Driver
- Hole centers: 98-108mm / 3.8-4.2"

### Power

- Current: Max 1 Amp

### Durability & standards

- Mechanical vibration: 10G
- Operating temperature: -40 to +85°C / -40 to +185°F
- CE marked
- E-Marked: UNECE R10 compliant
- SAE J994
- NAS/PIEK approved for night-time delivery

## WHITE SOUND® BACK UP ALARM

BBS-107 - Heavy duty - 107 Decibels

0899

BBS-102 - Heavy duty - 102 Decibels

0898



- 12-24Vdc
- IP68
- Size (WxHxD)  
172 x 79 x 95mm  
6.8 x 3.1 x 3.7 inches
- Lifetime warranty

### Features

- Multi-frequency broadband sound
- Instantly locatable
- Sound confined to danger area
- Eliminates noise nuisance
- Sounder unit: Driver
- Hole centers: 153mm / 6"

### Power

- Current: Max 1 Amps

### Durability & standards

- Mechanical vibration: 10G
- Operating temperature: -40 to +85°C / -40 to +185°F
- CE marked
- E-Marked: UNECE R10 compliant
- SAE J994

## WHITE SOUND® BACK UP ALARM

BBS-82HV - Electric forklift - 82 Decibels

1322

BBS-92ADR - Petrol tanker - 92 Decibels

2165



ADR version



- 12-24Vdc
- 36-80Vdc (HV)
- IP68
- Size (WxHxD)  
127 x 76 x 65mm  
5 x 3 x 2.5 inches
- Lifetime warranty

### Features

- Multi-frequency broadband sound
- Instantly locatable
- Sound confined to danger area
- Eliminates noise nuisance
- Sounder unit: Speaker
- Hole centers: 98-108mm / 3.8-4.2"

### Power

- Current: Max 0.3 Amps

### Durability & standards

- Mechanical vibration: 10G
- Operating temperature: -40 to +85°C / -40 to +185°F
- CE marked
- E-Marked: UNECE R10 compliant
- SAE J994

**Model**

**Part No:**

**WHITE SOUND® BACK UP ALARM**



<b>BBS-97 - Medium duty - 97 Decibels</b>	<b>0935</b>
<b>BBS-92 - Medium duty - 92 Decibels</b>	<b>0934</b>
<b>BBS-87 - Medium duty - 87 Decibels</b>	<b>0897</b>
<b>BBS-82 - Medium duty - 82 Decibels</b>	<b>0896</b>



noise abatement society



- 12-24Vdc
- IP68
- Size (WxHxD)  
105 x 65 x 37mm /  
4.1 x 2.5 x 1.5 inches  
(BBS-97/92)  
105 x 65 x 32mm /  
4.1 x 2.5 x 1.3 inches  
(BBS-87/82/77)
- Lifetime warranty

**Features**

- Multi-frequency broadband sound
- Instantly locatable
- Sound confined to danger area
- Eliminates noise nuisance
- Sounder unit: Speaker
- Hole centers: 76mm / 3"

**Power**

- Current: Max 0.5 Amps

**Durability & standards**

- Mechanical vibration: 10G
- Operating temperature:  
-40 to +85°C / -40 to +185°F
- CE marked
- E-Marked: UNECE R10 compliant
- SAE J994
- NAS/PIEK approved for night-time delivery (BBS-82 only)

**QVS QUIET VEHICLE SOUNDER (AVAS)**

**QVS-001-75 - Quiet Vehicle Sounder**

**5385**



- 12-24Vdc
- IP68 Speaker
- IP30 ECU
- Size Speaker (WxHxD)  
120 x 135 x 120mm  
4.7 x 5.3 x 4.7 inches
- Size ECU (WxHxD)  
93 x 26 x 185mm  
3.7 x 0.2 x 7.3 inches
- 2 year warranty



**Contents**

- 1 x Speaker
- 1 x ECU

**Features**

- Warns pedestrians and other VRU's that a quiet vehicle is approaching
- Combined multi-frequency bbs-tek® technology and tonal sounds
  - Multi-frequency sound
  - Directional and locatable - The sound is only heard in the hazard zone.
- Front speaker system
- Pitch and volume increase with vehicle speed to mimic an internal combustion engine
- Operational below speeds of 20MPH
- Front sounder operational when ignition activated (silenced when parking brake applied)
- Uses Tachograph speed signal\*\*
- Sounder unit: Speaker

**Power**

- Current: Max 0.1 Amps

**Durability & standards**

- Mechanical vibration: 10G
- Operating temperature:  
-30 to +70°C / -22 to +158°F
- CE marked
- E-Marked: UNECE R10 compliant
- FCC approved
- IC Marked
- UNECE R138 compliant\*
- 49 CFR Part 571 and 585 Federal Motor Vehicle Safety Standards compliant\*

\* QVS helps achieve compliance for the vehicle.

\*\* If your vehicle is not equipped with a Tachograph, please contact us for alternative installation methods

**QVS Quiet Vehicle Sounder (AVAS)**

- Warns pedestrians and other vulnerable road users that a quiet vehicle is approaching.
- Incorporating bbs-tek® technology - Multi-frequency, directional and instantly locatable sound which is only heard in the hazard zone.
- Front speaker system.
- Pitch and volume increase with vehicle speed in a similar way as an internal combustion engine.
- Sound fades out above a pre-set speed threshold.
- Designed for electric and hybrid-electric vehicles of all types.





# Speaking Alarms

**Model**

**Part No:**

## NIGHTSHIFT® SPEAKING ALARM



**BC-01(NS) - Single reversing message - Nightshift - 90 or 0 Decibels**  
**BC-01(NS-B) - Bespoke single message - Nightshift - 90 or 0 Decibels**

**0378**  
**1198**

- 12-24Vdc
- IP68
- Size (WxHxD)  
122 x 84 x 50mm  
4.8 x 3.3 x 2 inches
- 2 year warranty

**Features**

- Real speech alarm
- \* BC-01(NS) message "Ssh! Stand well clear, vehicle reversing..."
- Bespoke message up to 8 seconds, under 4 seconds for best speech quality
- Double engage reverse to cut-out or reduce sound
- Sounder unit: Speaker
- Hole centers: 102mm / 4"

**Power**

- Current: 0.5 Amps

**Durability & standards**

- CE marked
- E-Marked: UNECE R10 compliant

## SPEAKING ALARM



**BC-01 - Single reversing message - 90 Decibels**  
**BC-01(B) - Bespoke single message - 90 Decibels**  
**BC-02(B) - Bespoke dual message - 90 Decibels**

**0077**  
**0079**  
**0083**

- 12-24Vdc
- IP68
- Size (WxHxD)  
122 x 84 x 50mm  
4.8 x 3.3 x 2 inches
- 2 year warranty

**Features**

- Real speech alarm
- \* BC-01 message "Ssh! Stand well clear, vehicle reversing..."
- Bespoke message up to 8 seconds, under 4 seconds for best speech quality
- Sounder unit: Speaker
- Hole centers: 102mm / 4"

**Power**

- Current: 0.5 Amps

**Durability & standards**

- CE marked
- E-Marked: UNECE R10 compliant

**Model**

**Part No:**

**SPEAKING HANDBRAKE WARNING ALARM**



2 wire version

**BC-01(H/Brake) - Single message - 2 wire - 90 Decibels**  
**BC-01(4W)(H/Brake) - Single message 4 wire - 90 Decibels**

**0849**  
**1715**

- 12-24Vdc
- IP68
- Size (WxHxD)  
122 x 84 x 50mm  
4.8 x 3.3 x 2 inches
- 2 year warranty

**Features**

- Real speech alarm
- \* Message "Bleep! Handbrake not applied..."
- Sounder unit: Speaker
- Hole centers: 102mm / 4"

**Power**

- Current: 0.5 Amps

**Durability & standards**

- CE marked
- E-Marked: UNECE R10 compliant

**SPEAKING SIDE TURN WARNING ALARM**



**SS-BC-08 - Single side-turn message - 90 Decibels**

**1334**

- 12-24Vdc
- IP68
- Size (WxHxD)  
122 x 84 x 50mm  
4.8 x 3.3 x 2 inches
- 2 year warranty

**Features**

- Real speech alarm
- \* Message "Ssh! Caution. Truck turning left..."
- Sounder unit: Speaker
- Hole centers: 102mm / 4"

**Power**

- Current: 0.5 Amps

**Durability & standards**

- CE marked
- E-Marked: UNECE R10 compliant

Note: TS-001ECU Turn indicator trigger is required 1362

**Model**

**Part No:**

**VEHICLE INTERCOM**



**BC-VI - Normally open channel rear to cab; button press cab to rear**  
**BC-VI-2 - Normally closed channel; button press communication**

**0815**  
**0875**

- 12-24Vdc
- IP68
- Size (WxHxD)  
122 x 84 x 50mm  
4.8 x 3.3 x 2 inches
- 2 year warranty

**Features**

- Two-way communication system
- Master unit volume control: 80-95dB
- Includes master unit, slave unit and 25m cable
- Sounder unit: Speaker
- Hole centers: 102mm / 4"

**Power**

- Current: 0.5 Amps

**Durability & standards**

- CE marked
- E-Marked: UNECE R10 compliant
- FCC Approved
- IC Approved

**ALARM ANCILLARIES**



**TCO-47 - Timed auto-reset reversing alarm cut-out (dash mount)**

**0663**

- 12-24Vdc
- 2 year warranty

**Features**

- Single touch timed relay
- Allows driver to cut-out alarm if reversing between the hours of 11.30pm-7.00am
- Auto-resets after 3-4 mins delay

**Durability and Standards**

- CE marked
- EMC approved

**ALARM ANCILLARIES**



**TCO-47-01 - Latched side-turn alarm cut-out (dash mount)**

**4752**

- 12-24Vdc
- 2 year warranty

**Features**

- Single touch timed relay
- Allows driver to cut-out alarm between the hours of 11.30pm-7.00am
- Resets by switch or ignition

**Durability and Standards**

- CE marked
- EMC approved

**ALARM ANCILLARIES**

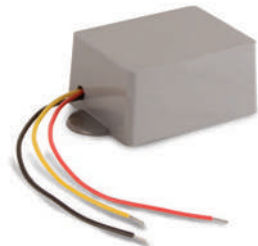

**NS-2 - Nightshift reversing alarm cut-out switch**  
**NS-3 - Nightshift reversing alarm cut-out switch (auto gearbox)**

**0334**  
**0974**

- 12-24Vdc
- IP68
- 2 year warranty

**Features**

- Double engage reverse to cut-out alarm
- Resets when reverse gear disengaged
- No wiring necessary to cab

**Durability and Standards**

- CE marked
- EMC approved

# Warranties

**LIFETIME**

## Lifetime New-For-Old Warranty (covers product for the life of vehicle)

bbs-tek® White sound® back up alarms  
Self-adjusting back up alarms

**5  
YEARS**

## 5 Year New-For-Old Warranty

Backeye®360 camera system  
ELITE range camera monitor systems

**3  
YEARS**

## 3 Year New-For-Old Warranty

SELECT range camera monitor systems  
MDR mobile digital recorders, IP cameras and accessories  
Ultrasonic object detection systems  
Backsense® radar object detection systems  
Digital wireless camera monitor connection

**2  
YEARS**

## 2 Year New-For-Old Warranty

Camera monitor system ancillaries  
Ultrasonic object detection on-screen display  
Ultrasonic object detection ancillaries and extras  
Alarm ancillaries  
Backchat® Speaking alarms  
Vehicle intercom  
QVS Quiet vehicle sounder

**1  
YEAR**

## 1 Year New-For-Old Warranty

ESSENTIAL camera monitor systems  
All products aside those specifically listed

## Warranty Terms and Conditions

Brigade warrants all goods to be free from defect in material and workmanship in normal use provided that they have been installed and operated in accordance with the instructions supplied. Normal wear-and-tear excluded. The commencement date of all warranties is the date of delivery to the purchaser unless otherwise agreed in writing by Brigade. The period during which the warranty applies is stated above. Brigade make no other warranty, express or implied, with respect to the goods, their marketability, quality or fitness for any particular use or purpose. In particular, but without prejudice to the general provisions of the conditions of sale, no responsibility is assumed for incidental or consequential loss by reason of any warranty express or implied. Full details of Brigade's Terms and Conditions can be found at [www.brigade-inc.com](http://www.brigade-inc.com).



# Index by Model Number

Model	Part	Page	Model	Part	Page	Model	Part	Page
AC-006	1983	38	BE-856GM	3756	16	CT-470	1346	60
AC-007	1984	38	BE-870FM	2146	16	DMC-1021	5715	31
AC-007	1984	62	BE-870LM	2705	16	DMC-1031	5303	25
AC-014	2094	38	BE-891C	5426	18	DMC-1035	5304	25
AC-014(5M)	5049	38	BE-901C	5278	17	DW-1001-RX	4282	40
AC-016	2150	39	BE-970WFM	3560	15	DW-1001-TX	4283	40
AC-019	2589	39	BE-970WM	3351	15	EDM-50	2152	41
AC-020	2590	38	BE-991C	5280	17	FS-4000W	3747	56
AC-020	2590	62	BE-L1003	2797	19	IP-1000C	5935	48
AC-021	2704	39	BE-L101	5042	19	IP-1100C	5936	49
AC-024	3183	39	BE-L105	0804	19	IP-1200C	5937	48
AC-028	3335	39	BE-L108	3007	19	IP-1XXX-PC	5985	49
AC-035	3702	42	BE-L110	0803	19	IP-EC-1	5865	49
AC-041	4245	39	BE-L112	3008	19	IP-EC-5	5866	49
AC-042	4246	39	BE-L115	0802	19	IP-EM-PC	5864	49
AC-044	4279	39	BE-L120	0801	19	IP-EM4	5860	49
AC-045	4280	39	BE-L130	0800	19	IP-EM8	5861	49
AC-055(5M)	4267	38	BE-X003	0805	19	IP-L601	5867	49
AC-056	4401	38	BE-X005	2099	19	IP-L603	5902	49
AC-062	4691	38	BE-X010	2100	19	IP-L605	5903	49
AC-063	4925	38	BE-X015	2101	19	IP-L610	5982	49
AC-064	4948	39	BE-X020	1143	19	IP-L615	5904	49
AC-066	5027	38	BE-X025	1907	19	IP-L620	5983	49
AC-067	5028	38	BKT-017	4676	61	IP-L630	5984	49
AC-068	5234	39	BKT-018	4758	61	LS-60-A	4851	40
AC-069	5318	39	BMM-019-ARM	3348	28	LS-60-A	4851	55
AC-24-12(002)	4266	39	BN-360-100C-BKT01	4649	10	MD-50AM-15	5004	31
AC-24-12(004)	4281	39	BN360-100C-BKT02	4714	10	MD-50AM-15	5004	26
AC-24-12(006)	4719	39	BN360-100C-BKT03	4743	10	MD-50AM-25	5005	26
AC-24-12(007)	4762	39	BN360-300	5800	10	MD-50AM-25	5005	31
AC-24-12(008)	4763	39	BN360-200	5200	11	MD-50SM-30	5003	26
AC-24-12(009)	4926	38	BE360-CD	4701	10	MD-50SM-30	5003	31
AC-305	4903	11	BN360-Enclosure	4723	11	MD-51	5736	31
AC-305	4903	38	BN360-H3025	5813	10	MD-51(SW)	5686	31
AC-305	4903	47	BN360-H305	5812	10	MD-51(W)	5694	31
AC-306	4904	38	BN360-H310	5811	10	MD-61	5738	26
AC-306	4904	47	BN360-H315	5810	10	MD-61(SW)	5690	26
AC-307	4905	38	BN360-H320	5809	10	MD-61(W)	5698	26
AC-307	4905	47	BN360-L1025	4499	11	MDR-03GSC	4874	47
AC-308	4949	38	BN360-L105	4498	11	MDR-06RPC	4873	47
BBS-102	0898	66	BN360-L110	4496	11	MDR-500-1000-MCU	5157	47
BBS-107	0899	66	BN360-L115	4495	11	MDR-500-2000-MCU	5330	47
BBS-82	0896	67	BN360-L120	4493	11	MDR-500-500-MCU	5132	47
BBS-82HV	1322	66	BS-00NT	5291	61	MDR-504-1000	5561	46
BBS-87	0897	67	BS-00NYC	5270	61	MDR-504-2000	5563	46
BBS-92	0934	67	BS-02DCX	5272	61	MDR-504G-1000	5569	46
BBS-92ADR	2165	66	BS-02PIC	5271	61	MDR-504G-2000	5571	46
BBS-97	0935	67	BS-05DCX	4550	61	MDR-504GW-1000	5573	46
BC-01	0077	72	BS-09DCX	4551	61	MDR-504GW-2000	5575	46
BC-01(4W)(H/BRAKE)	1715	69	BS-25DCSX	4975	61	MDR-504W-1000	5565	46
BC-01(B)	0079	68	BS-4000W	3744	53	MDR-504W-2000	5567	46
BC-01(H/BRAKE)	0849	69	BS-7030	4527	61	MDR-508-1000	5126	45
BC-01(NS-B)	1198	68	BS-7045	4528	61	MDR-508-2000	5577	45
BC-01(NS)	0378	68	BS-7060	4529	61	MDR-508G-1000	5128	45
BC-02(B)	0083	68	BS-8000	4530	60	MDR-508G-2000	5583	45
BC-VI	0815	70	BS-9000	5266	63	MDR-508G-EXP-0	S5543	47
BC-VI-2	0875	70	BS-9000-WD	5713	60	MDR-508GW-1000	5127	45
BE-801C	1905	18	BS-9001-OSD	5658	62	MDR-508GW-2000	5585	45
BE-801C(40)	2085C	18	BS-9001-USB	5656	62	MDR-508GW-EXP-0	S5542	47
BE-801C(78)	2084C	18	BS-WD-USB	5637	60	MDR-508W-1000	5129	45
BE-821C	2002	18	CS-020	1571	40	MDR-508W-2000	5579	45
BE-823C	5100	18	CS-3100	5261	56	MDR-508W-EXP-0	5311	47

Model	Part	Page	Model	Part	Page	Model	Part	Page
MDR-FPB32-01	4896	47	UDS-4.5SC	3720	57	VSK-50E-T	2542	33
MDR-GS-02	4988	47	UDS-7.0SC	5623	57	VSK-505E	4005	33
MDR-RP01	4872	47	UDS-OSD21-ECU	5347	52	VSP-47A	1847	33
NS-2	0334	70	UDS-RELAY-12	4216	54	VSP-47B	1846	33
NS-3	0974	70	UDS-RELAY-24	4215	54	VSP-57A	3869	33
QVS-001-75	5385	67	VBV-243M	5323	36	VSP-57B	3870	33
SA-BBS-107	1400	66	VBV-3001C	5455	25			
SA-BBS-97	1399	66	VBV-301C	5213	30			
SA-BBS-97HV	1398	66	VBV-3021C	5457	25			
SC-07	1046	20	VBV-321C	5217	30			
SC-07-24S	1227	33	VBV-481C	2843	30			
SC-15-01	3268	21	VBV-631C	5817	37			
SC-15-01	3268	33	VBV-650-000N	4766	37			
SC-7	1829	20	VBV-671-000	5816	37			
SD-32GB-IND	4875	47	VBV-7001C	5465	24			
SD-64GB-IND	4876	47	VBV-701C	2575	29			
SE-7104F-100	5378	11	VBV-7091C	5469	24			
SE-770-100	5379	11	VBV-7101C	5467	24			
SE-770H-300	6144	10	VBV-7104FM	4474	27			
SK-15-01	3427	21	VBV-711C	2808	29			
SK-15-04	3997	21	VBV-7191C	5471	24			
SK-15-04	3997	55	VBV-750-000N	4706	35			
SK-15-05	5066	11	VBV-750-311	4782	36			
SK-15-05	5066	33	VBV-750-910	4220	36			
SK-30E	1144	20	VBV-750M	4287	28			
SK-30E-T	1885	20	VBV-750M-S	4710	28			
SK-31E	1830	20	VBV-770-000N	4693	35			
SK-31E-T	1886	20	VBV-770-301	4779	35			
SK-50E	1570	23	VBV-770-311	4783	36			
SK-50E-A	1879	23	VBV-750-910	4221	36			
SK-31E-T	1886	23	VBV-770FM	4982	28			
SK-UDS-05	4219	55	VBV-770HM	5611	23			
SM-3XX-25	4596	25	VBV-770M	4288	27			
SM-3XX-25	4596	30	VBV-770M-S	4697	27			
SP-07C	1140	20	VBV-791C	2842	29			
SP-07T	1142	20	VBV-H4025	5522	26			
SP-15A-01	3423	21	VBV-H405	5519	26			
SP-15A-04	3955	21	VBV-H410	5516	26			
SP-15A-05	5064	33	VBV-H415	5514	26			
SP-15B-01	3422	21	VBV-H420	5513	26			
SP-15B-04	3956	21	VBV-L4020	5773	37			
SP-15B-05	5065	33	VBV-L4025	1554	32			
SP-7A	1827	20	VBV-L403	4977	32			
SP-7B	1828	20	VBV-L405	1499	32			
SS-002	3044	41	VBV-L406	3152	32			
SS-4100W	5257	55	VBV-L407	3151	32			
SS-4100W-000	5344	55	VBV-L410	1386	32			
SS-4200W	5916	54	VBV-L412	3106	32			
SS-4200W-000	6075	45	VBV-L415	3150	32			
SS-BC-08	1334	55	VBV-L420	1380	32			
SS-BC-08	1334	69	VBV-L430	2108	32			
ST-2100	5262	57	VBV-L505	4001	32			
ST-2100-60-A	5345	57	VBV-L510	3663	32			
TCO-41-01	4752	70	VBV-L520	3664	32			
TCO-47	0663	70	VCS-020	1844	40			
TCO-47-01	4752	55	VSK-30E	2538	34			
TS-001ECU	1362	55	VSK-30E-T	2542	34			
UDS-10BC	3716	55	VSK-31E	2539	34			
UDS-10BC	3716	57	VSK-31E-T	2543	34			
UDS-15BC	3746	57	VSK-305E	3871	34			
UDS-2.5BC	3717	57	VSK-50E	2540	33			
UDS-2.5SC	3719	57	VSK-50E-A	2540	33			

# Index by Part Number

Part	Model	Page	Part	Model	Page	Part	Model	Page
0077	BC-01	68	2085C	BE-801C(40)	18	3997	SK-15-04	55
0079	BC-01(B)	68	2094	AC-014	38	4001	VBV-L505	32
0083	BC-02(B)	68	2099	BE-X005	19	4005	VSK-505E	33
0334	NS-2	70	2100	BE-X010	19	4215	UDS-RELAY-24	54
0378	BC-01(NS)	68	2101	BE-X015	19	4216	UDS-RELAY-12	54
0663	TCO-47	70	2108	BE-L430	32	4219	SK-UDS-05	55
0800	BE-L130	19	2146	BE-870FM	16	4220	VBV-750-910	36
0801	BE-L120	19	2150	AC-016	39	4221	VBV-770-910	36
0802	BE-L115	19	2152	EDM-50	41	4245	AC-041	39
0803	BE-L110	19	2165	BBS-92ADR	66	4246	AC-042	39
0804	BE-L105	19	2538	VSK-30E	34	4266	AC-24-12(002)	39
0805	BE-X003	19	2539	VSK-31E	34	4267	AC-055(5M)	38
0815	BC-VI	70	2540	VSK-50E	33	4279	AC-044	39
0849	BC-01(H/BRAKE)	69	2541	VSK-50E-A	33	4280	AC-045	39
0875	BC-VI-2	70	2542	VSK-30E-T	34	4281	AC-24-12(004)	39
0896	BBS-82	67	2542	VSK-50E-T	33	4282	DW-1001-TX	40
0897	BBS-87	67	2543	VSK-31E-T	34	4283	DW-1001-RX	40
0898	BBS-102	66	2575	VBV-701C	29	4287	VBV-750M	28
0899	BBS-107	66	2589	AC-019	39	4288	VBV-770M	27
0934	BBS-92	67	2590	AC-020	38	4401	AC-056	38
0935	BBS-97	67	2590	AC-020	62	4474	VBV-7104FM	27
0974	NS-3	70	2704	AC-021	39	4493	BN360-L120	11
1046	SC-07	20	2705	BE-870LM	16	4495	BN360-L115	11
1140	SP-07C	20	2797	BE-L1003	19	4496	BN360-L110	11
1142	SP-07T	20	2808	VBV-711C	29	4498	BN360-L105	11
1143	BE-X020	19	2842	VBV-791C	29	4499	BN360-L1025	11
1144	SK-30E	20	2843	VBV-481C	30	4527	BS-7030	61
1198	BC-01(NS-B)	68	3007	BE-L108	19	4528	BS-7045	61
1227	SC-07-24S	33	3008	BE-L112	19	4529	BS-7060	61
1322	BBS-82HV	66	3044	SS-002	41	4530	BS-8000	60
1334	SS-BC-08	55	3106	VBV-L412	32	4550	BS-05DCX	61
1334	SS-BC-08	69	3150	VBV-L415	32	4551	BS-09DCX	61
1346	CT-470	60	3151	VBV-L407	32	4596	SM-3XX-25	25
1362	TS-001ECU	55	3152	VBV-L406	32	4596	SM-3XX-25	30
1380	VBV-L420	32	3183	AC-024	39	4649	BN-360-100C-BKT01	10
1386	VBV-L410	32	3268	SC-15-01	21	4676	BKT-017	61
1398	SA-BBS-97HV	66	3268	SC-15-01	33	4691	AC-062	38
1399	SA-BBS-97	66	3335	AC-028	39	4693	VBV-770-000N	35
1400	SA-BBS-107	66	3348	BMM-019-ARM	28	4697	VBV-770M-S	27
1499	VBV-L405	32	3351	BE-970WM	15	4701	BE360-CD	10
1554	VBV-L4025	32	3422	SP-15B-01	21	4706	VBV-750-000N	35
1570	SK-50E	22	3423	SP-15A-01	21	4710	VBV-750M-S	28
1571	CS-020	40	3427	SK-15-01	21	4714	BN360-100C-BKT02	10
1715	BC-01(4W)(H/BRAKE)	69	3560	BE-970WFM	15	4719	AC-24-12(006)	39
1827	SP-7A	20	3663	VBV-L510	32	4723	BN360-Enclosure	11
1828	SP-7B	02	3664	VBV-L520	32	4743	BN360-100C-BKT03	10
1829	SC-7	02	3702	AC-035	38	4752	TCO-41-01	70
1830	SK-31E	20	3716	UDS-10BC	55	4752	TCO-47-01	55
1844	VCS-020	40	3716	UDS-10BC	57	4758	BKT-018	61
1846	VSP-47B	33	3717	UDS-2.5BC	57	4762	AC-24-12(007)	39
1847	VSP-47A	33	3719	UDS-2.5SC	57	4763	AC-24-12(008)	39
1879	SK-50E-A	22	3720	UDS-4.5SC	57	4766	VBV-650-000N	37
1885	SK-30E-T	20	3744	BS-4000W	53	4779	VBV-770-301	35
1886	SK-31E-T	22	3746	UDS-15BC	57	4782	VBV-750-311	36
1886	SK-31E-T	20	3747	FS-4000W	56	4483	VBV-770-311	36
1905	BE-801C	18	3756	BE-856GM	16	4851	LS-60-A	40
1907	BE-X025	19	3869	VSP-57A	33	4851	LS-60-A	55
1983	AC-006	38	3870	VSP-57B	33	4872	MDR-RP01	47
1984	AC-007	38	3871	VSK-305E	34	4873	MDR-06RPC	47
1984	AC-007	62	3955	SP-15A-04	21	4874	MDR-03GSC	47
2002	BE-821C	18	3956	SP-15B-04	21	4875	SD-32GB-IND	47
2084C	BE-801C(78)	18	3997	SK-15-04	21	4876	SD-64GB-IND	47

Part	Model	Page	Part	Model	Page	Part	Model	Page
4896	MDR-FPB32-01	47	5385	QVS-001-75	67	5984	IP-L630	49
4903	AC-305	11	5426	BE-891C	18	5985	IP-1XXX-PC	49
4903	AC-305	38	5455	VBV-3001C	25	6075	SS-4200W-000	54
4903	AC-305	47	5457	VBV-3021C	25	6114	SE-770H-300	10
4904	AC-306	38	5465	VBV-7001C	24	S5542	MDR-508GW-EXP-0	47
4904	AC-306	47	5467	VBV-7101C	24	S5543	MDR-508G-EXP-0	47
4905	AC-307	38	5469	VBV-7091C	24			
4905	AC-307	47	5471	VBV-7191C	24			
4925	AC-063	38	5513	VBV-H420	26			
4926	AC-24-12(009)	38	5514	VBV-H415	26			
4948	AC-064	39	5516	VBV-H410	26			
4949	AC-308	38	5519	VBV-H405	26			
4975	BS-25DCSX	61	5522	VBV-H4025	26			
4977	VBV-L403	32	5561	MDR-504-1000	46			
4982	VBV-770FM	28	5563	MDR-504-2000	46			
4988	MDR-GS-02	47	5565	MDR-504W-1000	46			
5003	MD-50SM-30	26	5567	MDR-504W-2000	46			
5003	MD-50SM-30	31	5569	MDR-504G-1000	46			
5004	MD-50AM-15	26	5571	MDR-504G-2000	46			
5004	MD-50AM-15	31	5573	MDR-504GW-1000	46			
5005	MD-50AM-25	26	5575	MDR-504GW-2000	46			
5005	MD-50AM-25	31	5577	MDR-508-2000	45			
5027	AC-066	38	5579	MDR-508W-2000	45			
5028	AC-067	38	5583	MDR-508G-2000	45			
5042	BE-L101	19	5585	MDR-508GW-2000	45			
5049	AC-014(5M)	38	5611	VBV-770HM	23			
5064	SP-15A-05	33	5623	UDS-7.0SC	57			
5065	SP-15B-05	33	5637	BS-WD-USB	60			
5066	SK-15-05	11	5656	BS-9001-USB	62			
5066	SK-15-05	33	5658	BS-9001-OSD	62			
5100	BE-823C	18	5686	MD-51(SW)	31			
5126	MDR-508-1000	45	5690	MD-61(SW)	26			
5127	MDR-508GW-1000	45	5694	MD-51(W)	31			
5128	MDR-508G-1000	45	5698	MD-61(W)	26			
5129	MDR-508W-1000	45	5713	BS-9000-WD	60			
5132	MDR-500-500-MCU	47	5715	DMC-1021	31			
5157	MDR-500-1000-MCU	47	5726	MD-51	31			
5200	BN360-200	11	5738	MD-61	26			
5213	VBV-301C	30	5773	VBV-L4020	37			
5217	VBV-321C	30	5800	BN360-300	10			
5234	AC-068	39	5809	BN360-H320	10			
5257	SS-4100W	55	5810	BN360-H315	10			
5261	CS-3100	56	5811	BN360-H310	10			
5262	ST-2100	57	5812	BN360-H305	10			
5266	BS-9000	63	5813	BN360-H3025	10			
5270	BS-00NYC	61	5816	VBV-671-000	37			
5271	BS-02PIC	61	5817	VBV-631C	37			
5272	BS-02DCX	61	5860	IP-EM4	49			
5278	BE-901C	17	5861	IP-EM8	49			
5280	BE-991C	17	5864	IP-EM-PC	49			
5291	BS-00NT	61	5865	IP-EC-1	49			
5303	DMC-1031	25	5866	IP-EC-5	49			
5304	DMC-1035	25	5867	IP-L601	49			
5311	MDR-508W-EXP-0	47	5902	IP-L603	49			
5318	AC-069	39	5903	IP-L605	49			
5323	VBV-243M	36	5904	IP-L615	49			
5330	MDR-500-2000-MCU	47	5916	SS-4200W	54			
5344	SS-4100W-000	55	5935	IP-1000C	48			
5345	ST-2100-60-A	57	5936	IP-1100C	49			
5347	UDS-OSD21-ECU	52	5937	IP-1200C	48			
5378	SE-7104F-100	11	5982	IP-L610	49			
5379	SE-770-100	11	5983	IP-L620	49			



# Glossary

## **ADPCM**

An audio file format, optimized for storing digitised data at a low sampling rate.

## **AHD**

Analogue high definition video standard that uses standard cable to transmit HD video from cameras to Monitor/DVR

## **Amp**

Unit of electric current.

## **Auto-trigger**

Enables automatic triggering of an action e.g. display of rear camera view when reverse gear engaged.

## **AVAS**

Acoustic Vehicle Alert System (AVAS) automatically emits an external synthesized sound to enable pedestrians to be audibly aware of the vehicle's presence.

## **A/V input/output**

Communication connection between electronic devices.

### **- Input**

Receives audio/visual signals such as from DVD or satellite navigation

### **- Output**

Sends audio/visual signals to other devices such as to mobile digital recorder.

## **Brightness**

Brightness of the picture displayed on a monitor, measured in candelas per square metre (cd/m<sup>2</sup>). Higher the measure the brighter the picture.

## **CAN bus**

Controller Area Network is a robust vehicle standard designed to allow microcontrollers and devices to communicate with each other without a host computer.

A Controller Area Network (CAN bus) is a robust vehicle bus standard designed to allow microcontrollers and devices to communicate with each others' applications without a host computer.

## **CCD (Charged-Coupled Device)**

A tiny photocell used in cameras to convert light into a digital signal.

## **Contrast**

Light intensity ratio of a display device between darkest and lightest colour produced.

## **CE mark**

Confirmation that a product is in conformity with the essential requirements of any applicable directives e.g. 2004/108/EC (relating to Electromagnetic Compatibility).

## **CVBS**

Composite Video Blanking and Sync. An analogue video signal format that carries standard-definition video as a single channel.

## **Decibel (dB)**

Unit of measure of the pressure (intensity) of sound. The higher the rating the more intense the sound.

## **DWDR (Digital Wide Dynamic Range)**

Digitally Produces a greater dynamic range of luminosity for improved detail in highlights and shadows.

## **EMC (Electro-magnetic compatibility)**

Regulation concerning the type-approval tests for European automotive electronics.

### **- E**

United Nations mark for approved vehicle components sold into the EU. And in some other countries under UN-ECE Regulation 10

## **EN 13309:2010**

Construction machinery. Electromagnetic compatibility of machines with internal power supply

## **FCC mark**

Certification for electromagnetic interference on products manufactured or sold in the United States which comply with the Federal Communications Commission.

## **FMCW**

Frequency-Modulated Continuous Wave radar. A known stable frequency continuous wave is transmitted and then received from any reflecting objects.

## **Frequency**

Number of times a sound source vibrates per unit of time, measured in hertz (Hz). The higher the rating the higher the pitch.

## **GPS (Global Positioning System)**

Global satellite system providing positioning and timing services to worldwide users on a continuous basis.

## **HALT (Highly Accelerated Life Test)**

A comprehensive stress test applied to electronic equipment to identify design weakness.

## **IC (Industry Canada)**

Certification for electromagnetic interference on products manufactured or sold in Canada which comply with the Bureau of Innovation, Science & Economic Development

## **Illumination distance (camera)**

Distance a camera with infrared LEDs can see in ultra-low light conditions, measured in metres.

### **IP## (Ingress Protection)**

An international classification for the sealing of electrical equipment against the intrusion of solid objects (digit 1) and liquids (digit 2). Higher the rating the better protection in each case.

### **ISO 13766**

Specific standard for earthmoving equipment, includes requirements for some additional tests that are not covered in the tests for 'E' or 'e' under EMC.

### **ISO 16750**

Standard providing guidance regarding environmental conditions commonly encountered by electrical and electronic systems installed in vehicles.

### **ISO 20653: 2006**

Road vehicles — Degrees of protection (IP-Code) of electrical equipment against foreign objects, water and access

### **LCD (Liquid Crystal Display)**

Thin, flat display device made up of any number of colour or monochrome pixels i.e. monitor screen.

### **LED (Light Emitting Diode (camera))**

Emits infrared light for high efficiency and performance in ultra-low light.

### **LED (Light Emitting Diode (monitor))**

Used to back light the monitor display for crisp images and superior image quality.

### **Mechanical shock**

Level of sudden acceleration or deceleration, such as impact or being dropped, to which product will still perform. Measured in gravitational force (G).

### **Mechanical vibration**

Level of continuous or repetitive

motion, such as engine vibration, to which product will still perform. Measured in gravitational force (G).

### **NAS-PIEK**

The standard for quiet delivery vehicles in the UK, certified by the Noise Abatement Society.

### **NTSC (National Television Systems Committee)**

TV colour encoding standard.

### **PAL (Phase Alternating Line)**

TV colour encoding standard.

### **Quiet Mark**

An international approval associated with the UK Noise Abatement Society. It encourages companies worldwide to prioritise noise reduction.

### **R46**

UN ECE Regulation No 46 covers devices for indirect vision and their installation.

### **R118**

UN ECE Regulation No 118 determines the burning behaviour (ignitibility, burning rate and melting behaviour) of materials.

### **R138**

UN ECE Regulation concerning the approval of Quiet Road Transport Vehicles with regard to their reduced audibility.

### **Resolution (RGB)**

Number of pixels used to display an image. Measured in Width x 3 channels (Red, Green, Blue) x Height.

### **RoHS 2**

The restriction of the use of certain hazardous substances in electrical and electronic equipment

### **SAE J994**

Performance testing for electrically operated reversing alarms primarily intended for use on off-road, self-propelled construction and industrial machines.

### **Sounder unit**

Unit which produces the sound of an alarm.

### **TV Lines**

Number of horizontal lines used to create an image.

### **Viewing angles (camera)**

The maximum angle of vision.

### **Viewing angles (monitor)**

The maximum angle at which an image can be successfully viewed. Measured from the centre point on the monitor.

### **Vulnerable road user**

Road users most at risk in traffic – such as pedestrians, cyclists and public transport passengers. Children, older people and disabled people may also be included in this category.

### **Watt**

A measure of the electrical power needed to drive a product.

### **WDR (Wide Dynamic Range)**

Produces a greater dynamic range of luminosity for improved detail in highlights and shadows.

### **WiFi**

A facility allowing devices to communicate wirelessly. A wireless network creates a small, localised area within which your devices can receive signal.

### **4G**

A cellular data service available from mobile network providers.

# You're safer with us

Brigade is committed to making roads and worksites safer for all. From our humble beginnings in the UK, we now have a network of overseas subsidiaries and partnerships with international distributors, all chosen for their high level of service and expertise in vehicle safety.

Whether you operate an international, multi-vehicle fleet or a small business in a remote corner of the globe, We have a local specialist to help with your safety requirements. We can provide a solution for a specific problem or offer friendly advice and support if you are new to vehicle safety systems.

Wherever you are in the world, large road-going vehicles and mobile machinery continue to be a danger. Thankfully, Health & Safety culture is gradually improving to help combat these dangers, but whatever the local obligation, there is no excuse for compromising on safety.



## North America

- Brigade Electronics Inc
- Brigade Electronics (Canada) Limited
- National Distributor in Mexico

## South America

- National Distributors in Brazil, Chile, Argentina, Peru, Bolivia, Colombia

## United Kingdom

- Brigade Electronics Group Plc
- Brigade Electronics (UK) Ltd
- Brigade Service Partners:  
Experienced, accredited technicians who provide service and support for anyone who has purchased our products. Operating from over 20 regional sites nationwide, each with fully equipped workshops and a team of engineers providing extensive parts availability, support and advice
- Nationwide network of approved fitters, mobile engineers and over 150 distributors

## Europe

- Brigade Elektronik GmbH
- Brigade Elettronica srl
- Brigade Electronics BV
- Brigade Electronics FRANCE SAS
- Brigade Electronics (Polska) sp. z o.o.
- National Distributors in Austria, Denmark, Finland, Norway, Spain, Sweden, Switzerland, Bulgaria, Czech Republic, Greece, Hungary, Baltic States, Romania, Russia, Serbia, Slovenia, Turkey, Kazakhstan

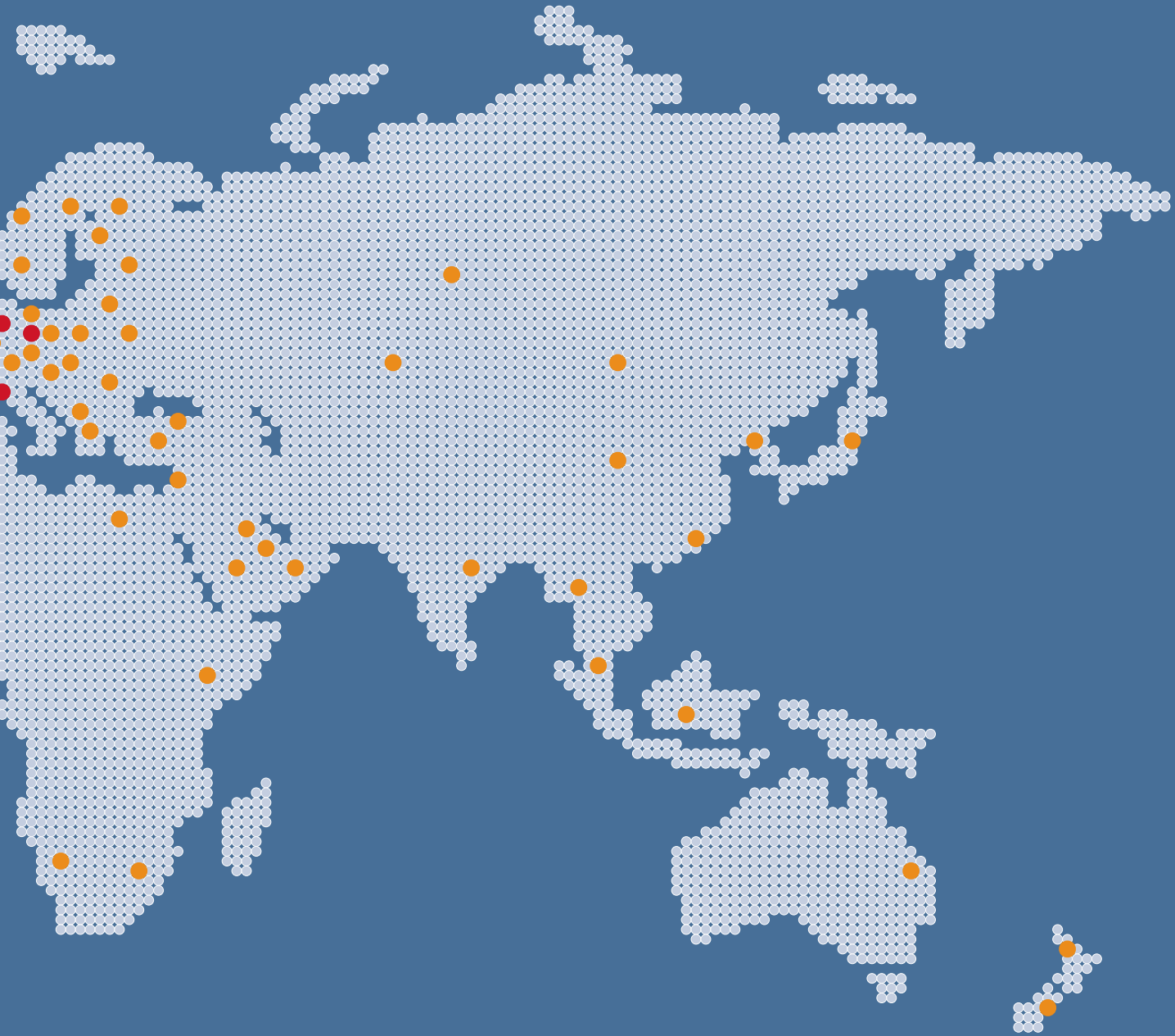

## Africa

- National Distributors in South Africa, Egypt, UAE, Oman, Israel

## Asia

- National Distributors in India, Pakistan, Mongolia, Hong Kong/China, Indonesia

## Australasia

- National Distributors in Australia, New Zealand



**“You’re safer with us”**



**MS FOSTER**

SERVING THE TRANSPORTATION INDUSTRY

1040 Highway 212  
Michigan City, IN 46360

OFFICE 219.879.9225  
TOLL FREE 888.452.4053  
FAX 219.879.9313

[sales@msfoster.com](mailto:sales@msfoster.com)  
[www.msfoster.com](http://www.msfoster.com)