

LED Headlights - Model 8700 Evo 2 Dual Burn

PRODUCT INFORMATION

Description	12-24V DOT LED High & Low Beam Headlight with Black Inner Bezel - Single Light
Height	176.53 mm / 6.95 in
Width	176.53 mm / 6.95 in
Depth	99.82 mm / 3.93 in
Shape	Round
Outer Lens Material	Polycarbonate
Outer Lens Color	Clear
Housing Material	Die-Cast Aluminum
Housing Color	Gray
Bezel Color	Black
Retrofits	2D1 "PAR56" or 7" round headlights
Minimum Operating Temperature	-40 °C / -40 °F
Maximum Operating Temperature	65 °C / 149 °F
Connector or Wiring	H4
Mating Connector	H4 AMP#172615-2
Product Weight	2.31 lbs / 1.05 kgs
Shipping Weight	3.50 lbs / 1.59 kgs

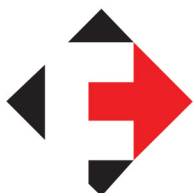

MS FOSTER

SERVING THE TRANSPORTATION INDUSTRY

1040 Highway 212
Michigan City, IN 46360

OFFICE 219.879.9225
TOLL FREE 888.452.4053
FAX 219.879.9313

sales@msfoster.com
www.msfoster.com

LED Headlights - Model 8700 Evo 2 Dual Burn

PRODUCT DIMENSIONS

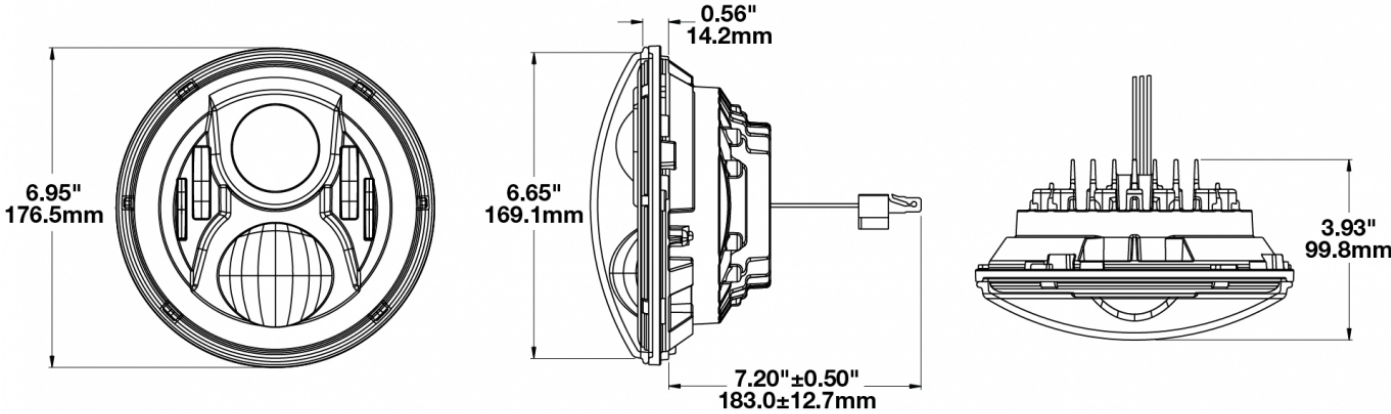

ELECTRICAL SPECIFICATIONS

Input Voltage	12-24V DC
Operating Voltage	9-32V DC
Transient Spike Protection	150V Peak @ 1 HZ-100 Pulses
Black Wire	Ground
White Wire	High Beam
Yellow Wire	Low Beam
Current Draw	3.50A @ 12V DC (High Beam) 2.00A @ 12V DC (Low Beam) 1.80A @ 24V DC (High Beam) 1.10A @ 24V DC (Low Beam)

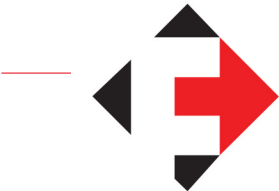

MS FOSTER

SERVING THE TRANSPORTATION INDUSTRY

1040 Highway 212
Michigan City, IN 46360

OFFICE 219.879.9225
TOLL FREE 888.452.4053
FAX 219.879.9313

sales@msfoster.com
www.msfoster.com

LED Headlights - Model 8700 Evo 2 Dual Burn

REGULATORY STANDARDS COMPLIANCE



Buy America Standards Eco Friendly
 FMVSS 108 s10.1 (Table XIX) FMVSS 108 s10.1 (Table XVIII)
 IEC IP67

PHOTOMETRIC SPECIFICATIONS

Raw Lumen Output 3,200 (High Beam); 1,770(Low Beam)
Effective Lumen Output 1,260 (High Beam); 750 (Low Beam)
Candela Output 71,500 (High Beam) 35,003 (Low Beam)
Nominal LED Color Temperature 5000 K
Beam Pattern(s) Forward Lighting - High Beam (DOT)
 Forward Lighting - Low Beam (DOT)

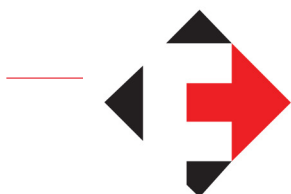
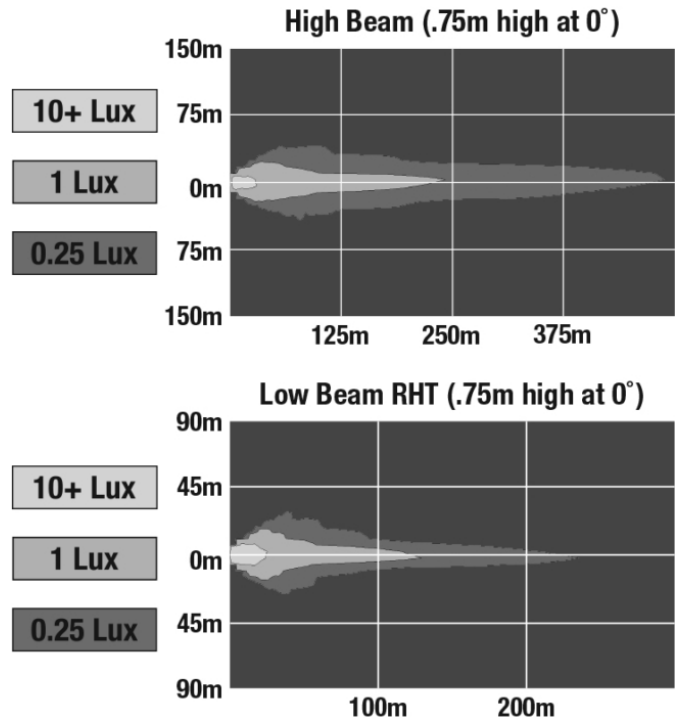

MS FOSTER

SERVING THE TRANSPORTATION INDUSTRY

1040 Highway 212
 Michigan City, IN 46360

OFFICE 219.879.9225
 TOLL FREE 888.452.4053
 FAX 219.879.9313

sales@msfoster.com
 www.msfoster.com

LED Headlights - Model 8700 Evo 2 Dual Burn

APPLICATIONS

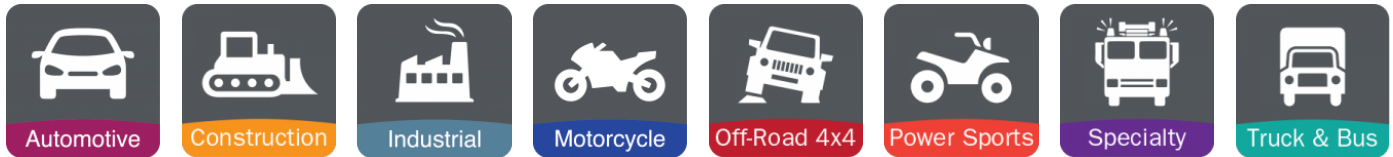

ADDITIONAL INFORMATION

Headlight must be securely mounted and properly aimed such that the beam pattern cut off line complies with all applicable regulations. If you are not familiar with the legal requirements for aiming your headlights, please see a professional service provider. We recommend that headlights are aimed with a headlight aiming system for proper alignment.

ACCESSORIES



Part Number
8000381
H4/H4 Anti-Flicker
Harness for J.W.
Speaker LED
headlights



Part Number
3156351
Mounting Ring Kit for
7" Round (PAR56)
Headlights



Part Number
3156561
Panel Mount Bucket
Assembly for 8700
Evolution & 8710
Series



Part Number
3266081
Jumper Harness
H4/H13 for 8700
Evolution & 8710
Series



Part Number
8000311
Anti-Flicker Harness
H4/H13 for 8700
Evolution Series
Headlights

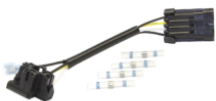

Part Number
8200411
Wire Harness H4 for 7"
Round (PAR56)
Headlights



MS FOSTER

SERVING THE TRANSPORTATION INDUSTRY

1040 Highway 212
Michigan City, IN 46360

OFFICE 219.879.9225
TOLL FREE 888.452.4053
FAX 219.879.9313

sales@msfoster.com
www.msfoster.com

LED Headlights - Model 8700 Evo 2 Dual Burn

RELATED PRODUCTS



Part Number
0552751

12-24V ECE LED LHT
High & Low Beam
Headlight with FP, DRL,
Black Inner Bezel -
Single Light



Part Number
0552761

12-24V ECE LED RHT
High & Low Beam
Headlight with FP, DRL,
Black Inner Bezel -
Single Light



Part Number
0553311

12-24V ECE LED LHT
High & Low Beam
Headlight with FP, DRL,
Chrome Inner Bezel -
Single Light



Part Number
0553321

12-24V ECE LED RHT
High & Low Beam
Headlight with FP, DRL,
Chrome Inner Bezel -
Single Light



Part Number
0554961

12-24V DOT LED High
& Low Beam Headlight
with Chrome Inner
Bezel - Single Light



Part Number
0554981

12-24V DOT LED High
& Low Beam Headlight
with Black Inner Bezel
& Mounting Ring -
Single Light



Part Number
0554991

12-24V DOT LED High
& Low Beam Headlight
with Chrome Inner
Bezel & Mounting Ring
- Single Light



Part Number
0556281

12-24V DOT LED High
& Low Beam Heated
Headlight with Black
Inner Bezel - Single
Light



MS FOSTER

SERVING THE TRANSPORTATION INDUSTRY

1040 Highway 212
Michigan City, IN 46360

OFFICE 219.879.9225

TOLL FREE 888.452.4053

FAX 219.879.9313

sales@msfoster.com

www.msfoster.com