



PROFESSIONAL LIFTING EQUIPMENT



DEPENDABLE PRODUCTS

QUALITY

SAFETY

PERFORMANCE



WHY SHOULD YOU CHOOSE NORCO?



PROFESSIONAL LIFTING EQUIPMENT

- Exceptional Customer Service
- Innovative Products
- Availability
- Durability
- Quality
- Best Value
- Knowledgeable Sales Team



SUPPLY CHAIN EXPERTISE

NORCO has four distribution centers, strategically located around the USA, to speed delivery to our customers and to their customers' job sites!



QUALITY YOU CAN COUNT ON

Our products are tested to meet the toughest industry standards. Our NORCO Limited Lifetime Warranty is a testimony to our commitment to offering the best quality and performance anywhere.



DESIGNING INNOVATIVE SOLUTIONS

NORCO designs and delivers many vehicle specific adapters for automobile and truck manufacturers. These unique tools save time when removing and installing parts, while enhancing technician safety. We also offer a wide array of dealership-friendly tools that won't mark tile or epoxy shop floors. NORCO works for innovative and cost-effective "win-win" solutions to problems.



NORCO DESIGNED & PATENTED PRODUCTS

While some of our products are *made* in the USA, some are *assembled* in the USA, and many are imported, one thing is certain: We provide products that we've designed to meet technician needs. Whether it is our US patented one pump to the load floor jacks, rolling lift bridge or underhoist transmission jacks, you can count on NORCO to provide you with a unique, time-saving tool for your shop needs.



COMPANY HISTORY

Thanks for taking the time to look through our catalog. NORCO was created in 1964 and we are now into our third generation of family ownership. It is our intent to make the best quality product, offered at the best possible price, for the professional repair marketplace. If you take a look at our various departments, executive-level management, manufacturing, sales support, or customer service, you will find decades of longevity with the company. It is a testament to the corporate values held here at NORCO. As for customer service...it's our goal to meet your needs with one call. So pick up the phone and let's get acquainted!

QUALITY STATEMENT

While NORCO's mission is to make money for all the stakeholders in our company, our goal...our commitment to you...is for you to be able to take any NORCO product off the shelf, put it into service, and have it work, **SAFELY**, right out of the box. Based on our warranty statistics, we are doing things right. "When Safety Depends on Performance" isn't just some tagline. It's our core belief, but it takes a thoughtful process to get it right. We identify needs. Our engineers design products to meet those needs. We build prototypes and test them extensively. Once we are satisfied, we build preproduction prototypes and test them again to meet the current ASME PASE standards. After the products are approved, and we decide to make and introduce them to the market, we test them again before we put them on the shelf. We believe in each and every one of our products and we do our best to ensure they are made tough enough so that once you sell them, you won't see them again!

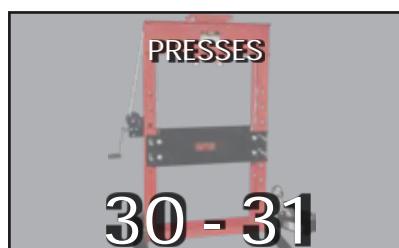
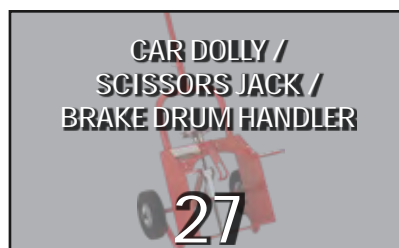
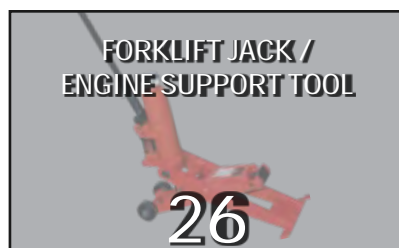
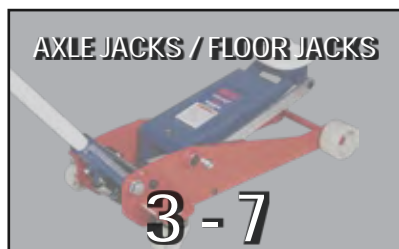

Assembled in the USA and ASME PASE

It is our intent to make as many products in the USA as possible. While we make some products that are 100% "Made in the USA," many of our products are "Assembled in the USA." We don't want to mislead the public, so we have come up with a single logo that will cover all of our products that have significant USA content. When you see our new "Assembled in the USA" logo next to a NORCO product, you can be assured that it has at least 51% USA content as required by the Buy American Act and Federal Acquisition Regulation (FAR).

"When Safety Depends on Performance" isn't just some tagline. It's the foundation of our business. When one of our most valued customers was asked why he chose NORCO for his shop equipment needs, he said, "The safety of our technicians depends on the performance of your products." Our equipment has earned that confidence because we use the latest ASME PASE safety standards for our design qualification testing. The ASME PASE standard applies to the design, testing, operation, maintenance, and inspection of portable automotive service equipment. Tirelessly working to meet those standards ensures our customers that our products are safe for the user and perform beyond their expectations. All NORCO products, whether imported or assembled in the USA, are confidently covered by the NORCO Limited Lifetime Warranty (details on back cover).

Thank you for the opportunity to offer you the best shop equipment value on the market.

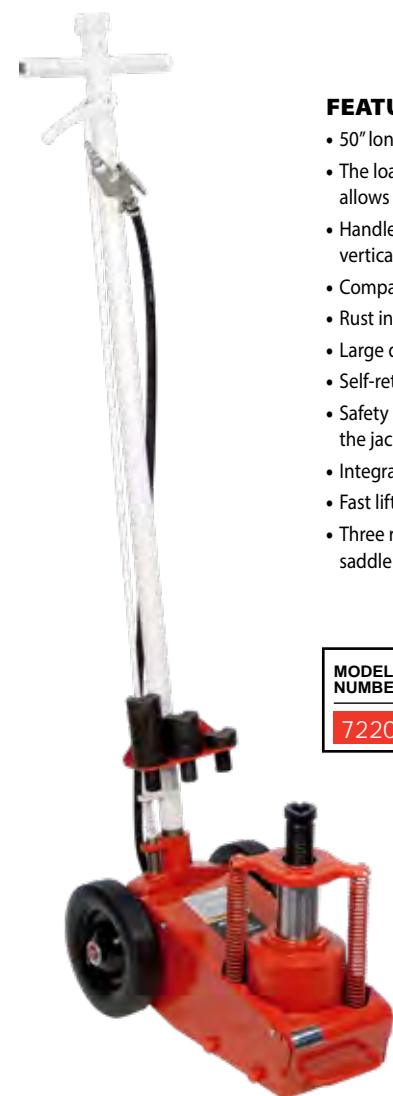

FEATURES

- 50" long "T" handle helps in positioning jack under vehicles with low overhang.
- The load release on the top mounted "T" handle allows operation in any handle position.
- Handle locking lever secures handle in either vertical, horizontal or 45 degree position.
- Compact design fits easily between tandem wheels.
- Rust inhibitive coating on ram and extension screw offers longer life.
- Large diameter wheels make maneuverability easy.
- Self-retracting ram eliminates manual lowering of jack.
- Safety bypass and overload systems prevent cylinder damage and prevent the jack from being used beyond the ASME/PASE load-limiting standard.
- Integrated filter protects air motor.
- Fast lifting air motor.
- Three removable 2" diameter saddles with handle mounted saddle holder; 3/4", 2-1/4" and 4" in height.

72200D

22 Ton Capacity

INTENDED USE

Ideal for heavy duty truck, agricultural and heavy construction equipment.

MODEL NUMBER	CAPACITY	LIFT HEIGHT		STROKE	SCREW EXTENSION	OVERALL DIMENSIONS		P.S.I. RANGE	SHIPPING WEIGHT
		Low	High			Length	Width		
72200D	22 Ton	9"	22"	4.75"	4.25"	20"	13"	85-145	115 lbs.

AMERICA'S FASTEST AND MOST DURABLE AXLE JACK!

AIR OPERATED HYDRAULIC JACKS

FEATURES

- Its light weight makes it perfect for mobile repair service.
- Long handle with 36-1/2" reach helps in positioning jack under vehicles with low overhang.
- May be stored in a vertical position.
- Compact design fits easily between tandem wheels.
- Parkerized coating on pump piston, extension screw and extension adapters and chrome coated ram offer protection against rust.
- Removable extension screw is used with the two 4" extension adapters (included) for added height when necessary.
- Self-retracting ram eliminates manual lowering of the jack.
- 5-1/4" diameter high impact composite wheels make maneuverability easy.
- Fast efficient air pump reduces lifting time and has a built-in relief mechanism which prevents the jack from being used beyond its maximum allowable capacity.
- Convenient push button air valve connected to an in-line filter prohibits contaminants from entering the air/hydraulic system.

72080A

Standard Height 20 Ton Capacity

72090A

Low Height 20 Ton Capacity

INTENDED USE

Heavy duty truck, agricultural and heavy construction equipment. Ideal for loaded truck and trailer roadside service calls.



*72080A 72090A (shown)

*NOTE: Models not shown have same basic construction as models pictured.

ITS LIGHT WEIGHT MAKES IT PERFECT FOR MOBILE REPAIR SERVICE!

MODEL NUMBER	CAPACITY	LIFT HEIGHT		STROKE	SCREW EXTENSION	BASE SIZE	P.S.I. RANGE	SHIPPING WEIGHT
		Low	High					
72080A	20 Ton	11.125"	28.625"	6.75"	2.75"	9.25" x 17.25"	100-130	70 lbs.
72090A	20 Ton	8.625"	22.75"	4.125"	2"	9.25" x 17.25"	100-130	63 lbs.

TIGHTER TOLERANCES, BETTER FINISHES, HIGHEST QUALITY!

72212

**55 / 37 / 23 / 12
Ton Capacity**

72218

**33 / 20
Ton Capacity**

72225

**50 / 25
Ton Capacity**

INTENDED USE

Heavy duty truck, rail, bus, agriculture and construction equipment applications.

72244

44 Ton Capacity

INTENDED USE

Heavy duty truck, agricultural and heavy construction equipment. Ideal for loaded truck and trailer roadside service calls. Heavy enough for rail and bus work.

FEATURES

- Long "T" handle helps in positioning jack under vehicles with low overhang.
- Handle locking lever secures handle in either vertical, horizontal or 45 degree position.
- Overload systems prevent cylinder damage and prevent the jack from being used beyond the ASME/PASE load-limiting standard.
- Rust inhibitive coating on rams offers longer life.
- Integrated filter protects air motor.
- Double acting pump raises ram more quickly to the load.
- Suspension loaded axle prevents wheel damage.
- Vacuum operated ram retraction eliminates manual lowering of jack.
- Safety button at the top of the handle can be pushed in to immediately stop the jack operation in case of emergency.
- Models 72212 and 72225 include a removable 2-3/4" diameter saddle, 2-9/16" and 5-7/8" long extensions with extension holder. Model 72218 includes 2" and 3-15/16" stackable extensions with extension holder.
- Model 72244 includes a removable 2-3/4" diameter saddle, 2" and 4" long stackable extensions and extension holder.

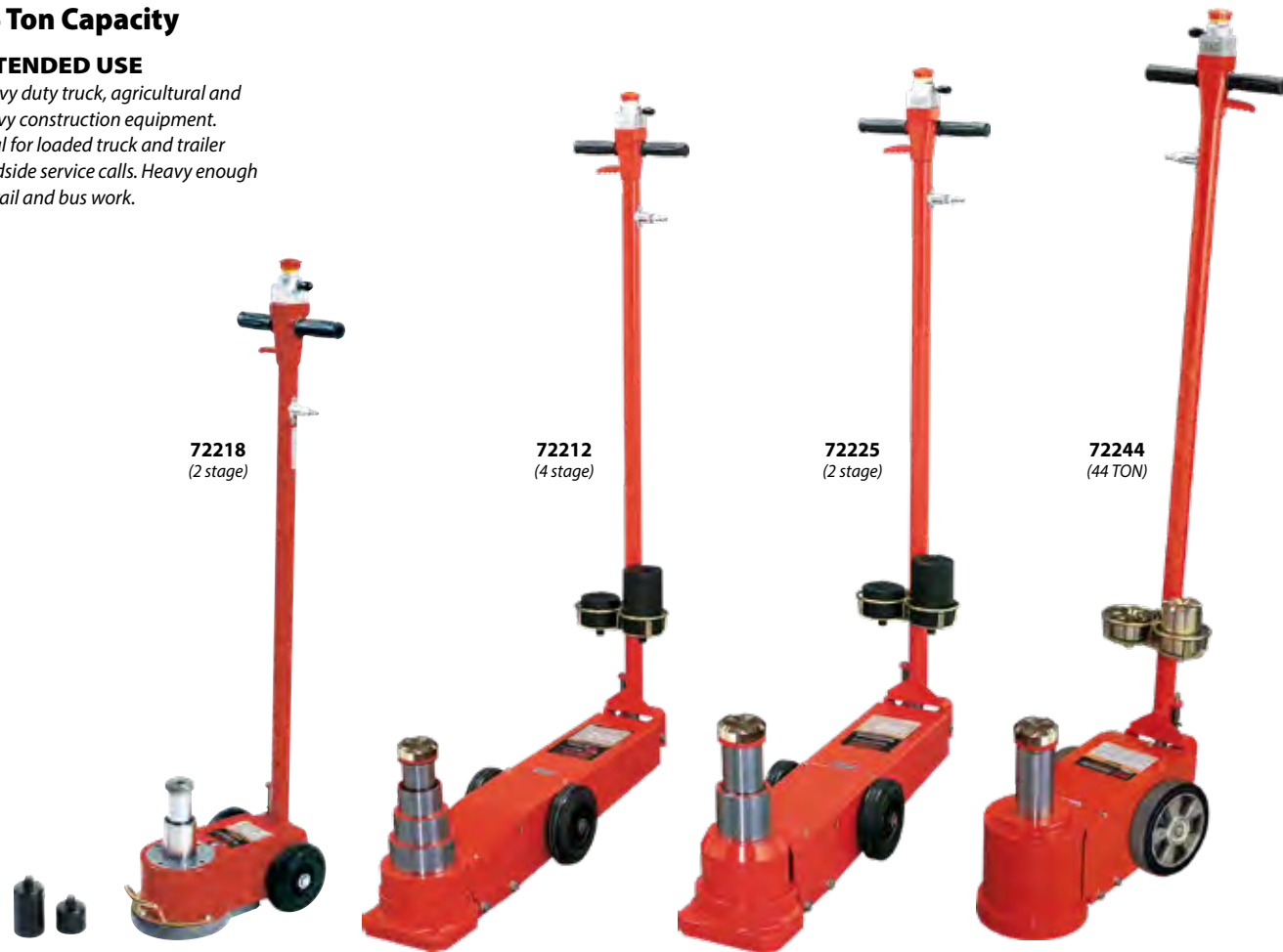

MODEL NUMBER	CAPACITY (TONS) @ LIFTING STAGE				LIFT HEIGHT		OVERALL DIMENSIONS		PISTON STROKE	HANDLE LENGTH	P.S.I. RANGE	SHIPPING WEIGHT
	1	2	3	4	Low	High	Length	Width				
72212	55	37	23	12	6"	15.375"	39.25"	8.625"	9.5"	61.75"	100-175	233 lbs.
72218	33	20	--	--	6"	12"	16"	6.75"	6.125"	49.25"	120-175	100 lbs.
72225	50	25	--	--	8.75"	16.5"	39.25"	8.625"	7.875"	61.75"	120-175	235 lbs.
72244	44	--	--	--	9.25"	15.625"	21.625"	8.125"	5.5"	61.75"	130-175	149 lbs.

FEATURES

- Chromed ram and dust seals prevent hydraulic contamination.
- Safety bypass and overload systems prevent cylinder damage and prevent the jack from being used beyond the ASME/PASE load-limiting standard.
- Air pump models can also be operated manually.
- **All models except for the 72230A include the FASTJACK® feature which raises the jack's lifting saddle to the load with one pump of the "T" handle.**
- Locking release lever secures handle in the vertical, 45 degree or horizontal position to lower the load on all models.

HIGHEST 5 TON LIFT HEIGHT ON THE MARKET!

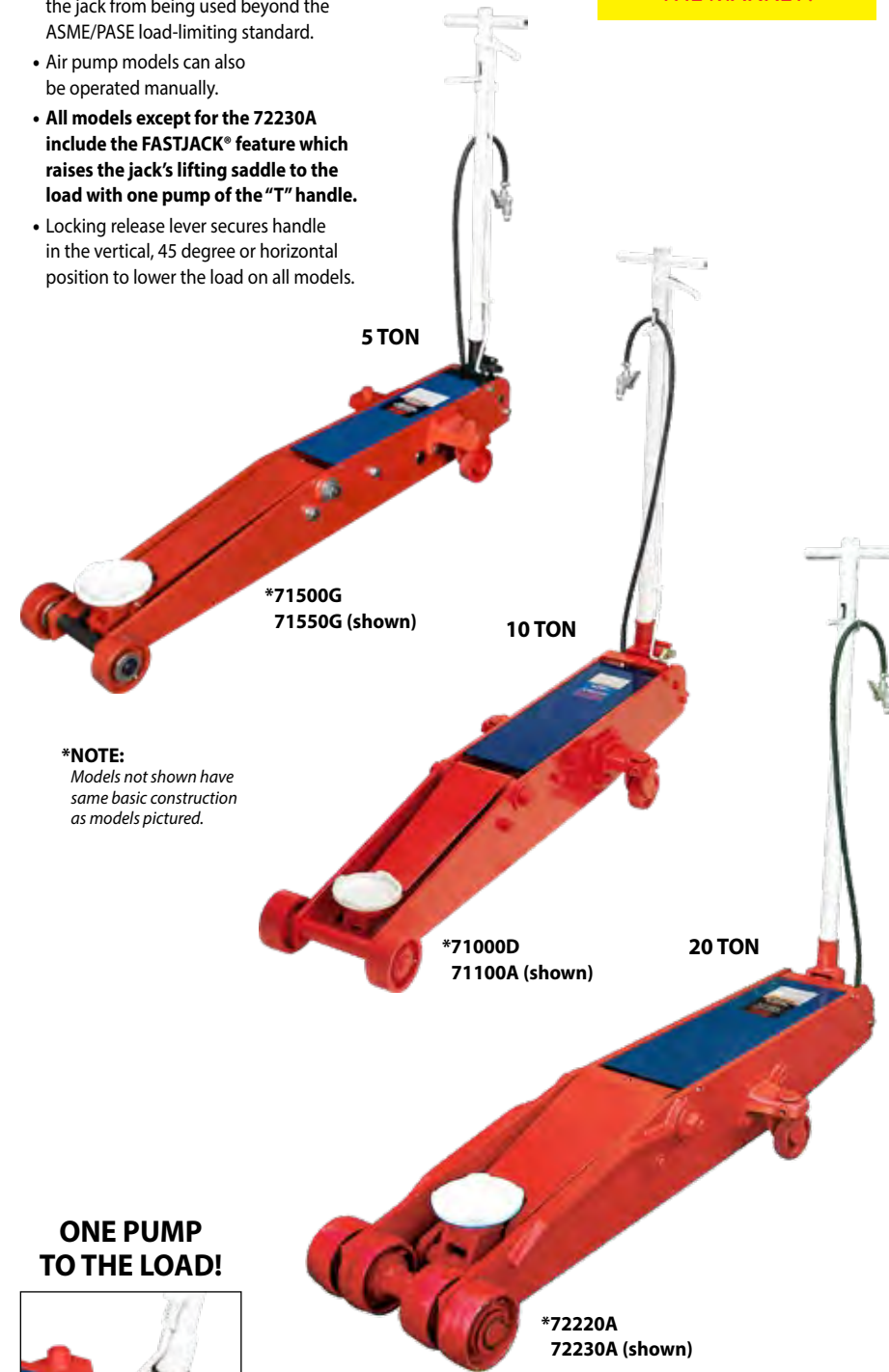

***NOTE:**
Models not shown have same basic construction as models pictured.

ONE PUMP TO THE LOAD!



FASTJACK® mechanism raises the jack's lifting saddle to the load in one pump stroke. U.S. PATENT NUMBER 7,055,801 B2

FASTJACK® 71500G

5 Ton Capacity

FASTJACK® 71550G

**5 Ton Capacity
Air / Hydraulic**

INTENDED USE

Truck fleet, truck and farm equipment dealers and bus company garages.

FASTJACK® 71000D

10 Ton Capacity

FASTJACK® 71100A

**10 Ton Capacity
Air / Hydraulic**

INTENDED USE

Heavy duty truck, heavy construction and agricultural equipment maintenance garages.

FASTJACK® 72220A

20 Ton Capacity

72230A

**20 Ton Capacity
Air / Hydraulic**

INTENDED USE

Heavy duty truck, heavy construction and agricultural equipment maintenance garages.

MODEL NUMBER	CAPACITY	LIFT HEIGHT		OVERALL DIMENSIONS		HANDLE LENGTH	SHIPPING WEIGHT
		Low	High	Length	Width		
71500G	5 Ton	5.625"	27.25"	62.25"	16.75"	40"	270 lbs.
71550G	5 Ton @ 120 P.S.I.	5.625"	27.25"	62.25"	16.75"	40"	270 lbs.
71000D	10 Ton	6.125"	27.25"	68.5"	21"	46.75"	455 lbs.
71100A	10 Ton @ 120 P.S.I.	6.125"	27.25"	68.5"	21"	46.75"	466 lbs.
72220A	20 Ton	7.25"	26.25"	71.5"	20.75"	45"	650 lbs.
72230A	20 Ton @ 120 P.S.I.	7.25"	26.25"	71.5"	20.75"	45"	670 lbs.

71202A **FASTJACK**

2 Ton Capacity Floor Jack

INTENDED USE

A heavy-duty professional quality floor jack designed for a variety of automotive shop uses including the day to day rigors of the tire changing industry.

FASTEST JACK ON THE MARKET, START TO FINISH!



71228

Steel Wheel Kit

Fits model 71202A
Weight: 10 lbs.



71226

Handle Protector Kit

Fits models 71202A, 71233A & 71335
Weight: 1 lb.



U.S. PATENT NO. 7,036,796

MODEL NUMBER	CAPACITY	LIFT HEIGHT		OVERALL DIMENSIONS		HANDLE LENGTH	SHIPPING WEIGHT
		Low	High	Length	Width		
71202A	2 Ton	3.5"	20.375"	28.75"	15.25"	49"	102 lbs.

71233A

2 Ton Capacity Double Pump Floor Jack

INTENDED USE

An economical floor jack designed for a variety of automotive shop uses where strength, speed, and dependability are required.



MODEL NUMBER	CAPACITY	LIFT HEIGHT		OVERALL DIMENSIONS		HANDLE LENGTH	SHIPPING WEIGHT
		Low	High	Length	Width		
71233A	2 Ton	2.75"	20"	27.875"	14.625"	50.25"	88 lbs.

FEATURES

- Fast acting pump raises jack to maximum height in 10-1/2 incremental pump strokes. Not only lifts fast to the load but lifts load fast.
- Angular pump piston provides efficient stroke no matter how far under the vehicle the jack is positioned.
- Patented air valve and oil passage design keep air pressure equalized in multiple oil cavities in hydraulic block to help maximize pumping efficiency.
- Nylon front and rear wheels to protect sealed floor surfaces and dealer showrooms.
- Thick steel side plates provide increased frame strength.
- 49" two-piece handle for easy shipping and storage.
- Safety bypass and overload systems prevent cylinder damage and prevent the jack from being used beyond the ASME/PASE load-limiting standard.

FEATURES

- Extremely low 2-3/4" low lift height.
- Safety bypass and overload systems prevent cylinder damage and prevent the jack from being used beyond the ASME/PASE load-limiting standard.
- Heavy duty chassis for added strength and dependability.
- 50.25" long two-piece handle for easy shipping and storage.
- Foam handle sleeve is included to protect vehicles from damage.
- Dual pump piston design raises the jack to maximum height in 8-1/2 pump strokes.
- U-joint release mechanism for more control.

FEATURES

- Thick aluminum side plates.
- 48" long two-piece handle with foam handle sleeve.
- Heavy duty aluminum front and rear wheels.
- Two-speed pump piston raises the saddle to the load quickly.
- Two grab handles provide more convenient lifting of the jack.
- Steel lift saddle for greater durability and strength.
- High lift height may be increased by 3" with optional model 71303 extension adapter.
- Safety bypass and overload systems prevent cylinder damage and prevent the jack from being used beyond the ASME/PASE load-limiting standard.

LIGHTWEIGHT COMBINATION OF ALUMINUM W/ STEEL PARTS USED IN CRITICAL AREAS FOR GREATER DURABILITY!



U.S. PATENT NO. D683104 & 9,022,356

MODEL NUMBER	CAPACITY	LIFT HEIGHT		OVERALL DIMENSIONS		HANDLE LENGTH	SHIPPING WEIGHT
		Low	High	Length	Width		
71330	3 Ton	3.75"	19"	26"	13.5"	48"	59 lbs.

FEATURES

- Steel hydraulic block construction includes a double pump piston design that quickly raises the jack to the maximum height.
- 50" long, two piece handle with knurled hand grip and foam handle sleeve provides:
 - Ease of pumping.
 - Longer reach for positioning under overhang.
 - Ease of transportation and storage.
 - Ease of pumping in tight quarters when second handle section is removed.
- 4" low and 21-3/8" maximum lift heights (without saddle adapter).
- 7" low and 24-3/8" maximum lift heights (with saddle adapter).
- Heavy-duty chassis for added strength and dependability.
- Safety bypass and overload systems prevent cylinder damage and prevent the jack from being used beyond the ASME/PASE load-limiting standard.
- Also available is our unique 3" saddle extension adapter (Model 71303). Its patented design has been created to quickly lift the load. Since most SUVs and service trucks have a higher low lift height, the increased height of the saddle allows for quicker positioning and quicker lifting of the vehicle. It saves time and effort and increases shop efficiency.

HIGHEST LIFT HEIGHT ON THE MARKET WITH 71303 EXTENSION ADAPTER!



U.S. PATENT NO. D683104 & 9,022,356

MODEL NUMBER	CAPACITY	LIFT HEIGHT		OVERALL DIMENSIONS		HANDLE LENGTH	SHIPPING WEIGHT
		Low	High	Length	Width		
71335	3-1/2 Ton	4"	21.375"	28.5"	14.375"	50"	106 lbs.

71330

3 Ton Capacity Lightweight Floor Jack

INTENDED USE

A lightweight jack designed for a variety of automotive shop uses. Ideal for roadside service calls.

71303

3" Saddle Extension Adapter

Fits model 71330 & 71335
Weight: 5 lbs.



71335

3-1/2 Ton Capacity SUV & Service Truck Jack

INTENDED USE

A heavy-duty floor jack designed for a variety of automotive shop uses including the added capacity and maximum lift height required to handle most SUVs and 1 Ton+ service trucks.

71303

3" Saddle Extension Adapter

Fits model 71330 & 71335
Weight: 5 lbs.



81004C & 81006D

**Pairs of Stands
3 & 6 Ton Capacity**

(Each Stand)

INTENDED USE

For automotive use where vehicle is to be supported before making repairs.

81012

**Pair of Stands
12 Ton Capacity**

(Each Stand)

INTENDED USE

Fleet garages, agricultural and construction maintenance shops.

FEATURES

- Unique spring loaded pawl provides constant locking pressure against lifting column.
- Four legged base with foot pads for added strength and a more secure footing on asphalt.
- Common machine bolt secures lifting column to stand and provides added strength when stand is continuously lifted and handled by the column.
- Recessed column saddle for acceptance of vehicle panel rail (model 81004C only).
- Positive lock handle cannot be disengaged until load is off the saddle column. Lock handle can be used as a carrying handle.

ALL STANDS ARE INTENDED TO BE USED IN PAIRS.

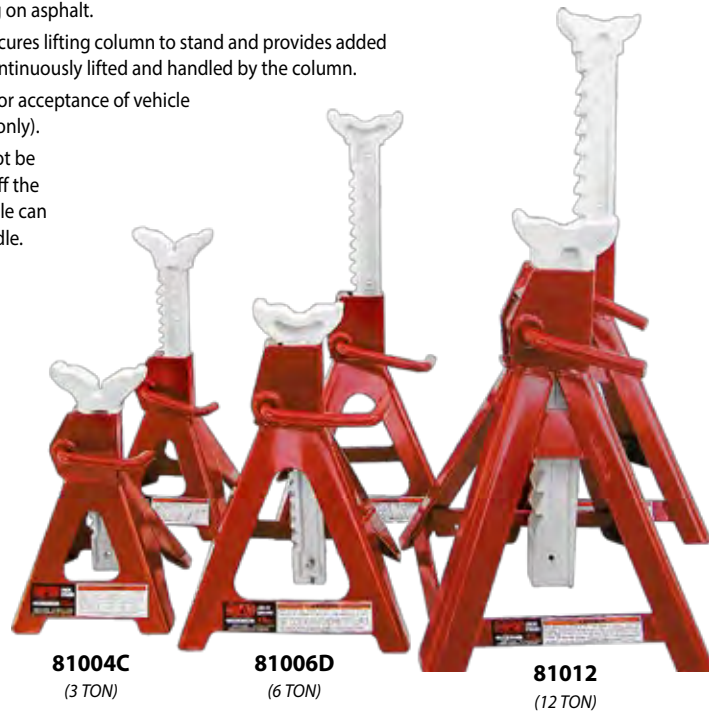

MODEL NUMBER	CAPACITY (Each Stand)	HEIGHT		HEIGHT INTERVALS	BASE SIZE	SADDLE SIZE	SHIPPING WEIGHT
		Low	High				
81004C	3 Ton	12"	17.5"	.5625"	7.5" x 7.875"	1.125" x 4.625"	19 lbs.
81006D	6 Ton	16.25"	24.875"	.625"	10" x 11"	1.125" x 4.875"	30 lbs.
81012	12 Ton	19.625"	29.375"	1.25"	13" x 15"	1.625" x 4.75"	86 lbs.

ADDED FEATURES MAKE OUR JACK STANDS SAFER AND BETTER!

TRUCK RAMPS

82019

82020

**Pair of Truck Ramps
20 Ton Capacity**

(10 Ton Each Ramp)

INTENDED USE

Elevates front or rear of vehicle for access to frame and components. Particularly useful on vehicles with low profile or ground-effects.

FEATURES

- Handles tires with up to 16" tread widths.
- Telescopic 34" T-handle extends and lifts up to expose wheels for easy maneuverability around the shop. Retracts for easy storage.
- Perforated holes in ramps provide traction for the tires.
- Non-skid rubber base pads prevent slippage when driving onto or off of ramps.

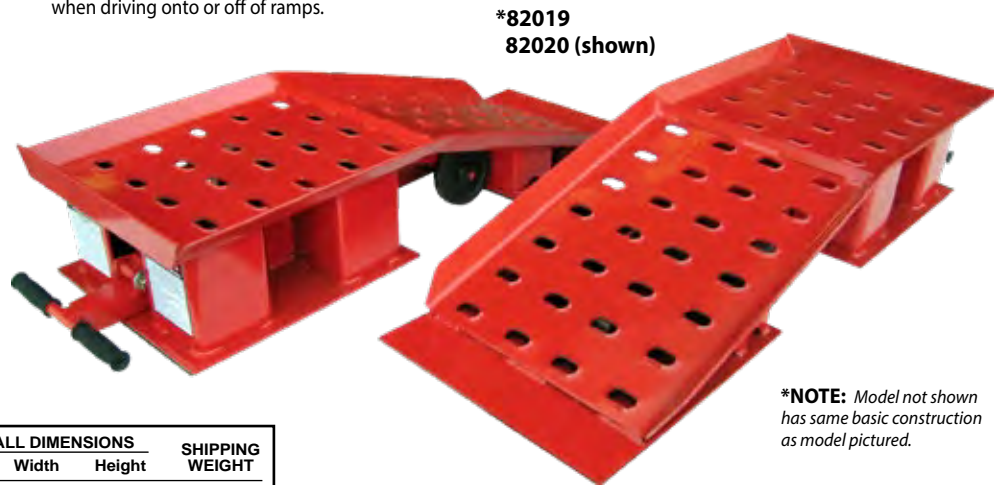

***82019
82020 (shown)**

***NOTE:** Model not shown has same basic construction as model pictured.

MODEL NUMBER	CAPACITY (Each Ramp)	OVERALL DIMENSIONS			SHIPPING WEIGHT
		Length	Width	Height	
82019	10 Ton	48.25"	12.625"	9"	204 lbs.
82020	10 Ton	50.5"	18.375"	9.25"	346 lbs.

**USA OR IMPORT.
YOUR CHOICE!**

81205

IMPORT 81205i

**5 Ton Capacity
Pair of Stands**

(5 Tons each stand)

INTENDED USE

Low profile design in order to support forklifts and heavy machinery.

81208

IMPORT 81208i

**10 Ton Capacity
Pair of Stands
(Short Height)**

(10 Tons each stand)

81209

IMPORT 81209i

**10 Ton Capacity
Pair of Stands
(Medium Height)**

(10 Tons each stand)

81210

IMPORT 81210i

**10 Ton Capacity
Pair of Stands
(High Height)**

(10 Tons each stand)

INTENDED USE

Fleet garages, agricultural and construction maintenance shops where a pin type height adjustment column is desired.

81225

IMPORT 81225i

**25 Ton Capacity
Pair of Stands**

(25 Tons each stand)

INTENDED USE

Fleet and maintenance garages where low profile stands are used to support trucks and loaded trailers.



**81205 (shown)
*81205i
(5 TON)**

FEATURES

- Pin type support column adjusts to four different height positions.
- Pins chamfered for easier insertion into positioning holes.
- Adjustment pin is secured to stand to prevent loss.
- Handle provides ease of positioning and carrying.
- 9" square base secures and stabilizes load.

***NOTE:**

Models not shown have same basic construction as model pictured. Import models differ slightly from models made in U.S.A.

FEATURES

- Pin type support column adjusts to multiple height positions. See specification chart below.
- Pins chamfered for easier insertion into positioning holes.
- Adjustment pin is secured to stand to prevent loss.
- Four legged base made of heavy schedule 2" diameter pipe for added stability.
- Large support saddle with locating lugs position and center load.



***81208
*81208i
(SHORT HEIGHT)**

**81209 (shown)
*81209i
(MED. HEIGHT)**

***81210
*81210i
(HIGH HEIGHT)
(10 TON)**



**81225 (shown)
*81225i
(25 TON)**

FEATURES

- Pin type support column adjusts to four different height positions.
- Pins chamfered for easier insertion into positioning holes.
- Adjustment pin is secured to stand to prevent loss.
- Handle provides ease of positioning and carrying.
- 3/8" thick solid steel base plate for added stability.

ALL STANDS ARE INTENDED TO BE USED IN PAIRS.

MODEL NUMBER	CAPACITY (Each Stand)	HEIGHT		HEIGHT INTERVALS	BASE SIZE	SADDLE SIZE	SHIPPING WEIGHT	
		Low	High					
81205	81205i	5 Ton	9.5"	15.75"	3 x 2"	9" x 9"	3" x 4.5"	38 lbs.
81208	81208i	10 Ton	10.5"	17"	4 x 1.5"	12.5" x 12.5"	3" x 5"	60 lbs.
81209	81209i	10 Ton	18.5"	30"	7 x 1.5"	17" x 17"	3" x 5"	80 lbs.
81210	81210i	10 Ton	28"	47"	10 x 2"	16" x 16"	3" x 5"	106 lbs.
81225	81225i	25 Ton	12"	20"	3 x 3"	10" x 10"	2.25" x 3.25"	65 lbs.

81022A 
IMPORT 81022Ai

20 Ton Capacity Trailer Stabilizing Stand

INTENDED USE
 To stabilize and assist in supporting the front or rear end of a loaded or unloaded tractorless trailer. Sold individually but generally used in pairs.

- FEATURES (Models 81022A & 81022Ai)**
- Meets OSHA requirements for supporting trailers when loaded or unloaded.
 - 14" diameter base provides maximum leveling stability.
 - Quick adjust spin handle for ease of turning.
 - Large diamond plate saddle to grip the load.
 - 1-1/2" diameter, grade 5, heavy duty screw and nut provide maximum strength and fine adjustment.



81022A
81022Ai
(20 TON)

81033A
3/4 Ton Capacity
 81034A

3/4 Ton Capacity w/ Foot Pedal

INTENDED USE
 Designed to support vehicle components, not the vehicle. Ideal for exhaust system installation, shock absorber replacement and any task which requires relieving pressure off components.

- FEATURES (Models 81033A & 81034A)**
- Lightweight, slender design makes handling easy, even in close quarters.
 - Quick adjust spin handle with thrust bearing eliminates wear and provides ease of turning under load.
 - Foot pedal (Model 81034A only) generates 1" additional stroke and 400 pounds of force at the saddle.
 - Pedal may be locked in vertical position for storage or shipment.
 - 1-1/4" diameter acme threaded screw has 26-1/4" of travel.



81034A (shown)
81033A (without pedal)
(3/4 TON)

81035A
1-1/2 Ton Capacity

INTENDED USE
 To assist in stabilizing and supporting a vehicle that is raised by an in-ground or above-ground lift. Should be used in pairs.

- FEATURES (Model 81035A)**
- An adjustment pin chained to the stand secures the support column at 6 different height positions.
 - Quick adjust spin handle with thrust bearing eliminates wear and provides ease of turning under load.
 - 1-1/4" diameter acme threaded screw has 6-1/2" of travel for fine adjustment.
 - 5/8" thick rubber saddle pad.



81035A
(1-1/2 TON)

81036A 
1 Ton Capacity

INTENDED USE
 For lifting and positioning exhaust systems, shock absorbers and MacPherson struts. Hydraulic power will assist in freeing frozen spring shackles, aligning wheels and steering gear adjustments.

- FEATURES (Model 81036A)**
- Foot activated pump and lowering pedals allow use of both hands to position components.
 - Spring return lowering pedal automatically closes the release valve when foot is removed from pedal.
 - 16" hydraulic travel.
 - Telescopic support tube with nine height adjustments at 2-1/2" increments.
 - A 12" diameter, 3/8" thick steel base provides added stability.
 - Two 3" diameter wheels provide easy maneuvering of stand into work position or around the shop.



81036A
(1 TON)

MODEL NUMBER	CAPACITY (Each Stand)	LOW HEIGHT	EXTENDED HEIGHT	BASE SIZE	SADDLE SIZE	SHIPPING WEIGHT
81022A 81022Ai	20 Ton	39"	50.625"	14" Dia.	4.5" x 5"	52 lbs.
81033A	3/4 Ton	55.25"	81.5"	12" Dia.	1.625" x 5.25"	36 lbs.
81034A	3/4 Ton	55.25"	81.5"	12" Dia.	1.625" x 5.25"	40 lbs.
81035A	1-1/2 Ton	48.875"	85.375"	12" x 12" x 12"	3.25" x 3.25"	48 lbs.
81036A	1 Ton	56.25"	94.375"	12" Dia.	4" x 6.25"	51 lbs.



- FEATURES**
- Tilting saddle activated by an integrated screw with machine handle enables the clutch to be positioned in either a horizontal position for clearing underneath truck or vertical position for installation and removal.
 - 2" and 1-3/4" diameter spline shafts rotate 360° for clutch and engine alignment.
 - Air/hydraulic foot pump provides hands free operation and easy, convenient lifting.
 - Metered pump provides safe lowering of load.
 - Two-stage flash chromed rams inhibit rust from entering hydraulic system.
 - Polyurethane wheels provide protection for tile and epoxy floors.

U.S. PATENT NO. 7,171,807

MODEL NUMBER	CAPACITY	LIFT HEIGHT		BASE DIMENSIONS	SHIPPING WEIGHT
		Low	High		
72035	300 lbs.	38.25"	73.5"	35" x 35"	159 lbs.

ALLOWS FOR EASY CLUTCH REPAIR WITH OR WITHOUT A LIFT

- FEATURES**
- Clutch/flywheel removal and installation becomes a one man job.
 - Tilting saddle enables clutch to be positioned in either horizontal position for clearing underneath truck or vertical position for installation and removal.
 - Adjustment bolt on saddle aligns clutch and flywheel.
 - Spline shaft rotates 360 degrees, turns left and right for clutch and engine alignment. 2" and 1-3/4" spline shafts included.
 - Conveniently located release valve and 360 degree rotating pump handle allow jack to be operated in any work position.



FLOOR CLUTCH JACK

72030B
300 Lbs. Capacity Floor Type Hydraulic Clutch Jack

INTENDED USE
 To remove, install and transport (in the lowered position) both 14" and 15-1/2" heavy duty clutches and flywheels.



OPTIONAL EQUIPMENT for models 72030B & 72035

72033
Flywheel Adapter
 Weight: 7 lbs.

72037
Eaton® Fuller® Solo® 14 Spline Clutch Disc Tool
 Weight: 9 lbs.

MODEL NUMBER	CAPACITY	LIFT HEIGHT		OVERALL DIMENSIONS		SHIPPING WEIGHT
		Low	High	Length	Width	
72030B	300 lbs.	11.5"	37.75"	35"	26.5"	148 lbs.

72500E

**Telescopic
1/2 Ton Capacity
Single Pump
Transmission Jack**

INTENDED USE

Designed for the removal, installation and transportation (in the lowered position) of transmissions and transfer cases on passenger cars, vans and light trucks that are raised by an in-ground or above-ground lift.

THE WIDEST VARIETY OF TRANSMISSION JACKS ON THE MARKET

FEATURES

- Fully adjustable universal saddle with hand adjustable corner brackets and safety chain.
- Safety overload system prevents jack from being used beyond the ASME/PASE load-limiting standard.
- Foot operated pump and lowering pedals allow use of both hands to position and align saddle with transmission.
- Two-stage flash chromed rams inhibit rust from entering hydraulic system.
- Wide base with four easy rolling 4" diameter swivel ball bearing caster wheels, provides stability and easy maneuvering in its lowered position.
- Polyurethane wheels provide protection for expensive tile and epoxy floors.

MODEL NUMBER	CAPACITY	LIFT HEIGHT		BASE DIMENSIONS	SHIPPING WEIGHT
		Low	High		
72500E	1/2 Ton	35"	72"	34" x 37"	176 lbs.



THE ECONOMY OF MANUAL OPERATION WITH THE SPEED OF AIR MODELS

NOTE: See optional adapters and saddles on pages 14-15.

72550B

FASTJACK

**Telescopic
1/2 Ton Capacity
Double Pump
Transmission Jack**

INTENDED USE

Designed for the removal, installation and transportation (in the lowered position) of transmissions and transfer cases on passenger cars, vans and light trucks that are raised by an in-ground or above-ground lift.

FEATURES

- Fully adjustable universal saddle with hand adjustable corner brackets and safety chain.
- Safety overload system prevents jack from being used beyond the ASME/PASE load-limiting standard.
- Foot operated pump and lowering pedals allow use of both hands to position and align saddle with transmission.
- Two-stage flash chromed rams inhibit rust from entering hydraulic system.
- Wide base with four easy rolling 4" diameter swivel ball bearing caster wheels, provides stability and easy maneuvering in its lowered position.
- Two times faster rising action as model 72500E with no load or a load up to 400 pounds.
- Same rising action as model 72500E for loads between 400 and 1,000 pounds.
- Polyurethane wheels provide protection for expensive tile and epoxy floors.

U.S. PATENT NO. 5,975,496
(Double Pump Design)

MODEL NUMBER	CAPACITY	LIFT HEIGHT		BASE DIMENSIONS	SHIPPING WEIGHT
		Low	High		
72550B	1/2 Ton	35"	72"	34" x 37"	178 lbs.



NOTE: See optional adapters and saddles on pages 14-15.

SIMULTANEOUS OPERATION OF TWO-STAGE RAM FOR SPEEDY TRANSMISSION REPAIR

FEATURES

- Air/hydraulic foot pump provides hands free operation and easy, convenient lifting.
- Metered pump valve provides safe lowering of load.
- Fully adjustable universal saddle with hand adjustable corner brackets and safety chain.
- Safety overload system prevents jack from being used beyond the ASME/PASE load-limiting standard.
- Two-stage flash chromed rams inhibit rust from entering hydraulic system.
- Wide base with four easy rolling 4" diameter polyurethane, swivel ball bearing caster wheels (one is a locking caster wheel) provides stability and easy maneuvering in its lowered position.
- Polyurethane wheels provide protection for expensive tile and epoxy floors.

FASTJACK 72450B

**Telescopic
1/2 Ton Capacity
Air / Hydraulic
Transmission Jack**

INTENDED USE

Designed for the removal, installation and transportation (in the lowered position) of transmissions and transfer cases on passenger cars, vans and light trucks that are raised by an in-ground or above-ground lift.

U.S. PATENT NO. 7,171,807

MODEL NUMBER	CAPACITY	LIFT HEIGHT		BASE DIMENSIONS	SHIPPING WEIGHT
		Low	High		
72450B	1/2 Ton	36"	75"	34" x 34"	175 lbs.



FEATURES

- Air/hydraulic foot pump provides hands free operation and easy, convenient lifting.
- Metered pump valve provides safe lowering of load.
- Fully adjustable universal saddle with hand adjustable corner brackets and safety chain.
- Safety overload system prevents jack from being used beyond the ASME/PASE load-limiting standard.
- Two-stage flash chromed rams inhibit rust from entering hydraulic system.
- Comes with a larger 10-1/4" x 15-1/8" saddle plate and four adjustable "L"-shaped locating bars.
- Wide base with four easy rolling 4" diameter swivel ball bearing caster wheels (two are locking caster wheels) provides stability and easy maneuvering in its lowered position.
- The wheels, made from a phenolic resin, offer high impact resistance and are non-marking for protection of tile and epoxy floors.

FASTJACK 72475A

**Telescopic
3/4 Ton Capacity
Air / Hydraulic
Transmission Jack**

INTENDED USE

Designed for the removal, installation and transportation (in the lowered position) of transmissions and transfer cases on passenger cars and up to one ton capacity vans and trucks that are raised by an in-ground or above-ground lift.

U.S. PATENT NO. 7,171,807

MODEL NUMBER	CAPACITY	LIFT HEIGHT		BASE DIMENSIONS	SHIPPING WEIGHT
		Low	High		
72475A	3/4 Ton	36.5"	75.25"	36" x 36"	196 lbs.

For use with all NORCO floor and under hoist transmission jacks.

72531



Automotive to Heavy Duty Saddle Adapter

Allows any automotive adapter to be attached to any heavy duty under hoist transmission jack. Weight: 18 lbs.



72528



Ford 6R80 Adapter

For use on Ford 6R80 transmissions. Weight: 24 lbs.



72537



Chrysler 948 Adapter

Designed to enhance technician safety while dramatically reducing service time to remove and install the ZF9HP48 / 948TE transmissions. Weight: 20 lbs.



72508



Fuel Tank Saddle

An optional saddle adapter which is used in conjunction with a NORCO transmission jack to remove, install and transport (in the lowered position) automobile and light truck emptied fuel tanks and other undercar components. Weight: 37 lbs.



72525

Quick-Adjust Saddle

An optional saddle that replaces the 4 adjustable corner brackets found on the standard universal saddle. Weight: 19 lbs.



UNIQUE VEHICLE & SERVICE SPECIFIC ADAPTERS SAVE TIME & ENHANCE SAFETY

This unique adapter allows any NORCO automotive transmission saddle adapter to be used with the NORCO heavy duty transmission jacks: 72700A or 72701A. This economical design can save a shop thousands of dollars by allowing one transmission jack to be used for both heavy duty truck and automotive applications.

6R80 VEHICLE APPLICATIONS:

- 2008–2010 Ford Expedition
- 2008–2010 Lincoln Navigator
- 2008–2010 Ford Explorer
- 2007–2010 Ford Explorer Sport Trac
- 2008–2010 Mercury Mountaineer
- 2009–2012 Ford F-150
- 2011 Ford Territory (SZ-series TCDi model)
- 2011–2012 Ford Mustang V6, GT

72529



Ford Diesel Exhaust Adapter

Diesel Exhaust Adapter for F-250, 350, 450, 550 Super Duty with a 6.7L Diesel. Weight: 42 lbs.



FEATURES

- Handles automotive and light duty truck fuel tanks up to 40 gallon capacity. Tanks are to be emptied before handling.
- Four adjustable support risers with rubber pads protect the fuel tank and can be quickly positioned to fit many shapes and sizes.
- Includes two load restraint straps.

FEATURES

- Quickly adapts to the existing universal saddle plate.
- Four low profile ratcheting arms quickly and easily adjust to the transmission pan configuration.

UNIQUE VEHICLE & SERVICE SPECIFIC ADAPTERS SAVE TIME & ENHANCE SAFETY

For use with all NORCO floor and under hoist transmission jacks.



72533

DPF & Drive Shaft Installation Support Tool

Allows for the safe and secure removal and installation of DPFs, Drive Shafts, and automotive transmissions up to 750 lbs. The bean bag eliminates the need for individual DPF transmission adapters. Weight: 51 lbs.



72532

Ford DPS6 Adapter

This transmission saddle works with any NORCO automotive under hoist transmission jack. It is designed to enhance technician safety while dramatically reducing service time to remove and install DPS6 transmissions. Weight: 15 lbs.



72034

300 Lbs. Capacity Clutch Saddle

An optional saddle adapter which is used in conjunction with model 72500, 72550, & 72450 under hoist transmission jacks. Weight: 22 lbs.



72509

Ford 5R55W, 4R70W, 4X4N, AXOD Metric Adapter

This one adapter can quickly and easily be adjusted to fit four different transmission configurations. Weight: 38 lbs.



72512

Ford 6F50 Adapter

For use on Ford and Lincoln 6F50 and GM 4T60E transmissions. Weight: 25 lbs.



72004

Ford 6R140 Adapter

Weight: 32 lbs.



72514

Mercedes 722 Adapter

Weight: 12 lbs.

Visit norcoindustries.com for more details.



72513

Ford CDE4E Adapter

Weight: 17 lbs.

Visit norcoindustries.com for more details.



72527

Ford 4F27E Adapter

Weight: 15 lbs.

Visit norcoindustries.com for more details.



TECH FRIENDLY
OPEN-FRONT CHASSIS DESIGN

72050E

1/2 Ton Capacity

INTENDED USE

For removal and installation of automobile and light truck transmissions or differentials.

FEATURES

- Wide chassis with open front provides:
 - Wider opening for saddle and transmission to come lower to the ground for easy removal.
 - Efficient load distribution and stability.
 - Easy access to saddle tilt knobs.
- Fully adjustable universal saddle with adjustable corner brackets and safety chain.
- Safety overload system prevents jack from being used beyond the ASME/PASE load-limiting standard.
- Full 360 degree rotating pump handle operates in any position.
- Flash chromed ram inhibits rust from entering the hydraulic system.
- Four full-swivel ball bearing caster wheels for easy positioning.
- Wide chassis for efficient load distribution and stability.



MODEL NUMBER	CAPACITY	LIFT HEIGHT		OVERALL DIMENSIONS		SADDLE SIZE	SHIPPING WEIGHT
		Low	High	Length	Width		
72050E	1/2 Ton	7.375"	32.125"	36"	26.5"	7.125" x 8.125"	152 lbs.

NOTE: See optional adapters and saddles on pages 14-15.

72025

1-1/2 Ton Capacity

INTENDED USE

Same as the model 72000E but with a wider chassis opening plus a broader lift range to handle a larger variety of transmission configurations.

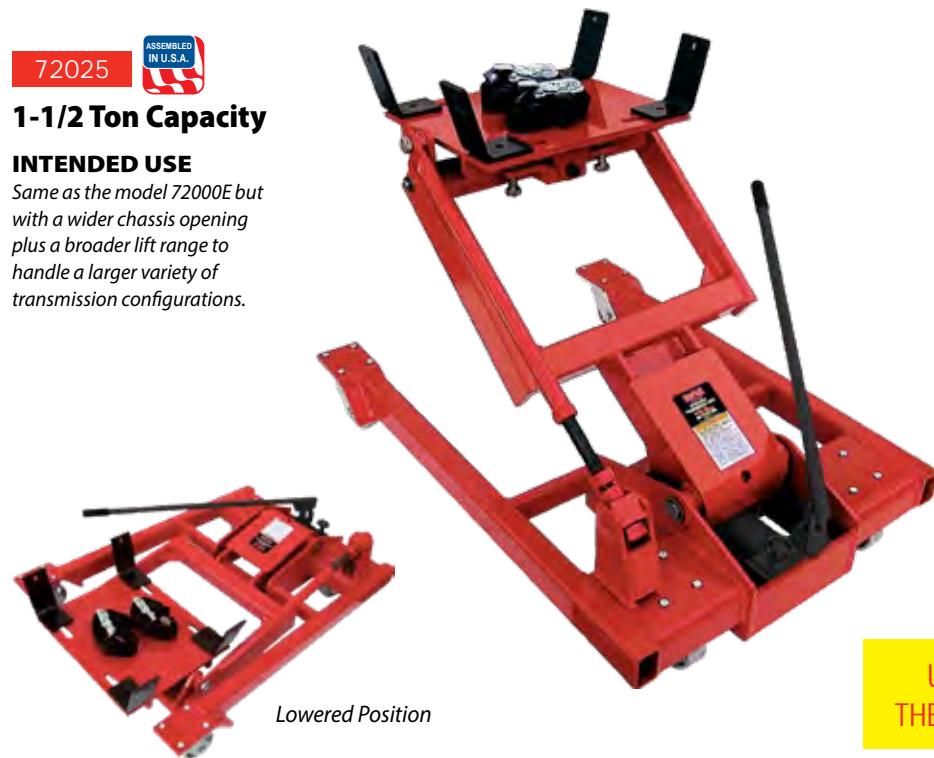

Lowered Position

UNIQUE SADDLE HANDLES
THE LARGEST TRANSMISSIONS

MODEL NUMBER	CAPACITY	LIFT HEIGHT		OVERALL DIMENSIONS			SADDLE SIZE	SHIPPING WEIGHT
		Low	High	Length	Width	Height		
72025	1-1/2 Ton	4.75"	36.5"	43.25"	32.75"	12"	18.25" x 15.25"	414 lbs.

DESIGNED WITH THE SERVICE
PROFESSIONAL IN MIND

FEATURES

- Wide chassis with open front provides:
 - Wider opening for saddle and transmission to come lower to the ground for easy removal.
 - Efficient load distribution and stability.
 - Easy access to saddle tilt knobs.
- Fully adjustable universal saddle with adjustable arms to position the transmission.
- Heavy duty chain with convenient chain tensioner secures load to the saddle.
- Safety overload system prevents jack from being used beyond the ASME/PASE load-limiting standard.
- Full 360 degree rotating handle operates in any position.
- Flash chromed ram inhibits rust from entering the hydraulic system.
- Four 4" diameter full-swivel ball bearing caster wheels for easy positioning.



72000E (shown)
*72000Ei

*NOTE:
Model not shown has same basic construction as model pictured. Import model differs slightly from model made in U.S.A.

MODEL NUMBER	CAPACITY	LIFT HEIGHT		OVERALL DIMENSIONS		SADDLE SIZE	SHIPPING WEIGHT
		Low	High	Length	Width		
72000E 72000Ei	1-1/2 Ton	7.75"	36.5"	45"	28"	10.25" x 15.25"	310 lbs.

72002

Security Ratchet Straps

Used to secure the load on any NORCO transmission jack. Rubberized coating on hooks. Weight: 5 lbs.



72001

Differential Adapter

Used with models 72000E, 72000Ei, 72700A and 72701A jacks only. Adapter fits most differentials and replaces the universal saddle when used. Weight: 29 lbs.



72003

Fuller® Eaton® Roadranger® Adapter

Used with model 72000E & 72000Ei jacks only. Weight: 21 lbs.



72700A

1 Ton Capacity

INTENDED USE

Designed for the removal, installation and transportation (in the lowered position) of heavy duty truck transmissions that are raised by an in-ground or above-ground lift.



MODEL NUMBER	CAPACITY	LIFT HEIGHT		BASE DIMENSIONS	SHIPPING WEIGHT
		Low	High		
72700A	1 Ton	45.75"	74.25"	38" x 38"	292 lbs.

72701A

1 Ton Capacity Air / Hydraulic

INTENDED USE

Same as the model 72700A but with the added convenience of an air/hydraulic foot pump.



MODEL NUMBER	CAPACITY @100 P.S.I.	LIFT HEIGHT		BASE DIMENSIONS	SHIPPING WEIGHT
		Low	High		
72701A	1 Ton	41.25"	69.375"	37.5" x 38"	273 lbs.

MANEUVERABILITY AND STABILITY FOR SAFE TRANSMISSION SERVICE

FEATURES

- Fully adjustable universal saddle with adjustable corner brackets and safety chain.
- Safety overload system prevents jack from being used beyond the ASME/PASE load-limiting standard.
- 2" diameter, flash chromed, single stage ram provides added stability throughout the entire lift range.
- Foot operated pump and lowering pedals allow use of both hands to position and align saddle with transmission.
- Wide base with four 3-7/8" diameter heavy duty swivel ball bearing caster wheels provides stability and easy maneuvering.

NOTE: See optional adapters and saddles on pages 14-15.

FEATURES

- Air/hydraulic foot pump provides hands free operation and easy convenient lifting.
- Metered pump valve provides safe lowering of load.
- Fully adjustable universal saddle with adjustable arms to position the transmission.
- Safety overload system prevents jack from being used beyond the ASME/PASE load-limiting standard.
- Heavy duty chain with convenient chain tensioner secures load to saddle.
- 2" diameter, flash chromed, single stage ram provides added stability throughout the entire lift range.
- Wide base with four 3-7/8" diameter heavy duty swivel ball bearing caster wheels provides stability and easy maneuvering.

NOTE: See optional adapters and saddles on pages 14-15.

HEAVIEST-DUTY POWERTRAIN LIFTS AVAILABLE

FEATURES

- Fingertip control for both pressure and release operations provides finer control of raising or lowering loads.
- Safety overload system in the air/hydraulic pump prevents jack from being used beyond the load-limiting standard.
- The pump can be removed from its holder and placed closer to the lift saddle, leaving hands free to accurately position the load.
- Fully adjustable saddle with two ratchet tie-downs secure the load to the saddle.
- Four easy rolling caster wheels (locking rear caster wheels) provides stability and easy maneuvering in its lowered position.
- The wheels, made from a phenolic resin, offer high impact resistance and are non-marking for protection of tile and epoxy floors.
- The optional model 72508 Fuel Tank Saddle Adapter (page 14) can be quickly and easily installed.



72674

1,250 Lbs. Capacity

INTENDED USE

The powertrain lift/table not only handles transmissions and fuel tanks, but also engines and transaxles, rear ends and leaf springs. Also serves as a work table where the components can be lowered to a stable and secure work height for repair.



Lowered Position

FEATURES

- An air/hydraulic foot pump includes a metered valve for safe lowering of the load.
- Safety overload system in the air/hydraulic pump prevents jack from being used beyond the load-limiting standard.
- Five foot extension hose with quick disconnect fittings stores in the lift base. The foot pump can be removed from its holder and hydraulic hose quickly and easily extended by 5' using the extension hose. This provides hands free operation of the pump anywhere around the lift's perimeter.
- Scissors lift design provides easy 360° access to any component.
- Two heavy duty ratchet tie-downs are included to safely secure the load on the lift table.
- Table top height from 31" to 80-1/2".
- Four 8" diameter swivel caster wheels for easy maneuverability. Rear wheels can be locked to prevent the lift from rolling.

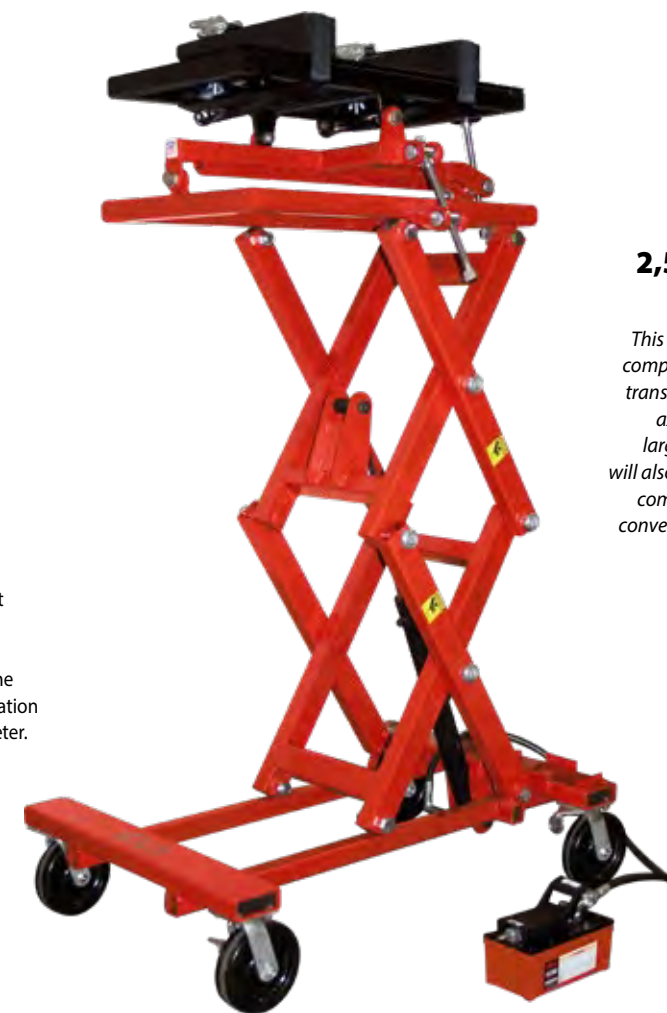

72850A

2,500 Lbs. Capacity

INTENDED USE

This lift/table handles powertrain components like engines and their transmissions, engines with trans-axle assemblies, rear ends and large electric vehicle batteries. It will also serve as a work table where components can be lowered to a convenient work height for repairs.

MODEL NUMBER	CAPACITY @100 P.S.I.	LIFT HEIGHT		OVERALL DIMENSIONS			TABLE SIZE	SADDLE TILT			SHIPPING WEIGHT
		Low	High	Length	Width	Height		Fwd.	Back	Side	
72674	1,250 lbs.	25.5"	65"	57"	42.75"	44.5"	20.25" x 32.25"	22°	22°	±17°	410 lbs.
72850A	2,500 lbs.	31"	78"	50"	33"	35"	19" x 36"	15°	15°	±15°	665 lbs.

SIDE-SHIFT FEATURE MAKES FOR EASY WHEEL ALIGNMENT

82302B 

1/2 Ton Capacity

INTENDED USE

For the removal and installation of single, tandem and duplex tires and wheels which are mounted on trucks that are supported above ground level.



FEATURES

- Heavy duty lift arms made with ball bearing conveyer rollers which allow easy rotation of wheels for alignment with bolt pattern.
- 7-1/2" of side to side lift arm adjustment eliminates the trial and error method of aligning the rim's lug holes with the wheel drum.
- A 1,500 pound capacity heavy duty winch with 5 to 1 gear ratio provides ease of operation.
- The winch gear design acts as a brake and allows the load to be lowered incrementally if desired and without the need for constant hand pressure against the crank handle.
- A hydraulic jack tilts the lift arms to match the angle of the spindle.
- Safety chain provided to secure tires and wheels to the dolly.
- Maneuverability is made easy by means of two rear mounted ball bearing caster wheels. The caster wheels include a locking mechanism which can prevent the dolly from moving.

82304 

1/2 Ton Capacity Air / Hydraulic

INTENDED USE

This uniquely crafted wheel lift is designed for the removal and installation of single, tandem, and duplex tires and wheels which are mounted on trucks that are supported above ground level.



FEATURES

- The unique, open-chassis design allows for much easier alignment than with the center post designs of our competition.
- Air-operated pump allows the unit to lift the load effortlessly.
- Heavy duty lift arms made with ball bearing conveyer rollers which allow easy rotation of wheels for alignment with bolt pattern.
- 7" of side to side lift arm adjustment allows for the easy alignment of the rim's lug holes with the wheel.
- 1,000 pound capacity.
- A hydraulic jack provides tilt to the lift arms for easy alignment.
- Safety chain provided to secure tires and wheels to the dolly.
- Maneuverability is made easy by means of two rear mounted ball bearing swivel casters. The caster wheels include a locking mechanism which can prevent the dolly from moving.

MODEL NUMBER	CAPACITY	LIFT HEIGHT		LIFT ARMS			SIDE to SIDE ADJ.		OVERALL DIMENSIONS			SHIPPING WEIGHT
		LOW	HIGH	WIDTH	LENGTH	TILT ANGLE	LEFT	RIGHT	L	W	H	
82302B	1/2 Ton	3"	41.25"	24.25"	21"	-2° to +30°	3.25"	4.25"	45.75"	43.75"	62"	315 lbs.
82304	1/2 Ton	2.125"	39.5"	30.875"	22.125"	-2° to +30°	2.5"	4.5"	49.625"	44.625"	69.875"	476 lbs.

FEATURES

- Rear swivel caster wheel and rigid front wheels provide positive steering for the model 82300D. Swivel caster wheels both fore and aft provide side to side maneuverability for the model 82301D.
- 4" wheels with polyurethane tread protect floor.
- Lift arms can be adjusted in closer to handle the more common dual wheel combinations and then adjusted outward to handle the larger combinations.
- Lift arms with ball bearing rollers easily rotate vehicle rim for bolt pattern alignment.
- Lift arms supported at both ends minimize wheel movement.
- Adjustable height push bar provides unobstructed access to hub area.
- 3-1/4" travel adjustment on rear caster wheel matches lifting arms with spindle angle.
- Safety chain included to secure wheel assembly to dolly during removal and transport.



82300D (shown) (with rear swivel caster)

82301D (swivel casters front & rear)

 82300D

1 Ton Capacity w/ Rigid Front Wheels

 82301D

1 Ton Capacity w/ Swivel Front Wheels

INTENDED USE
For the removal and installation of single, tandem and duplex tires and wheels.

MODEL NUMBER	CAPACITY	LIFT TRAVEL	OVERALL DIMENSIONS			SHIPPING WEIGHT
			Length	Width	Height	
82300D	1 Ton	7.5"	50.5"	44.5"	39"	207 lbs.
82301D	1 Ton	7.5"	50.5"	44.5"	39"	209 lbs.

DESIGNED AND BUILT IN AMERICA



FEATURES

- Dolly handles any tire diameter and up to 1,500 lbs. combined tire and wheel weight.
- Three 4" diameter swivel ball bearing caster wheels provide easy maneuverability & positioning.
- Travel adjustment on rear locking caster wheel matches lifting arms with spindle angle.
- 6' chain included to secure wheel assembly to dolly during removal & transport.
- Quick disconnect push/pull handle provides unobstructed access to hub area.

 82320

3/4 Ton Capacity Wheel Dolly

INTENDED USE
For the removal and installation of single, tandem and duplex tires and wheels.

MODEL NUMBER	CAPACITY	LIFT TRAVEL	LIFT ARMS		OVERALL DIMENSIONS			SHIPPING WEIGHT
			SPREAD	LENGTH	L	W	H	
82320	3/4 Ton	4.75"	26"	24.5"	43.5"	39.5"	35"	175 lbs.

THE MOST ECONOMICAL TIRE LEVER



FEATURES

- Heavy-duty tubular steel construction capable of handling 300 pounds.
- Easy grip handle along with improved "bent arm" design improves leverage for easier installation and minimizes back strain.
- Steel alignment rollers allow simple alignment of the wheel to the wheel studs.
- Spring-loaded kickstand offers convenient storage.
- Two models capable of handling tire diameters from 24 to 48 inches.

82310

Narrow Single Tire Handler Dolly

82312

Wide Single Tire Handler Dolly

INTENDED USE
To provide added leverage to easily remove or install truck tire-and-wheel assemblies.

MODEL NUMBER	HANDLES TIRES	OVERALL DIMENSIONS		SHIPPING WEIGHT
		Length	Width	
82310	24" - 36"	42.5"	24.75"	19 lbs.
82312	36" - 48"	41"	32"	22 lbs.

78160



3 Ton Capacity Diesel Engine Stand

INTENDED USE
For safe handling and positioning of most diesel engines.

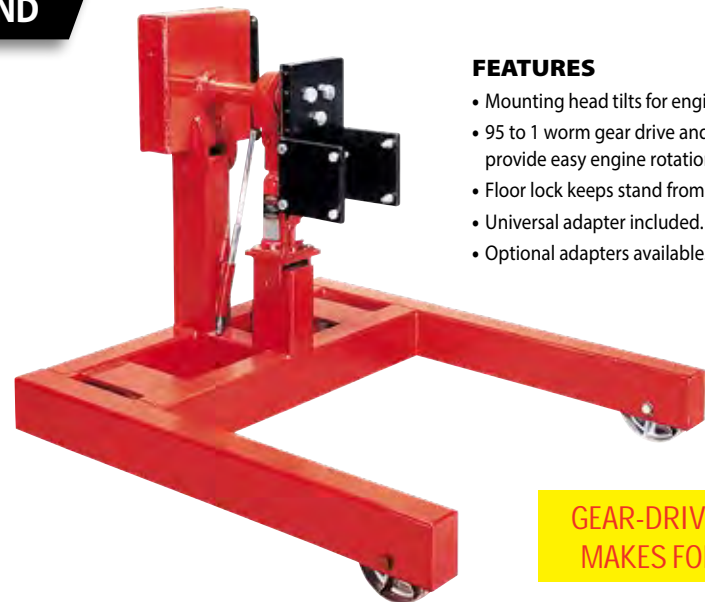

FEATURES

- Mounting head tilts for engine clearance in 360 degree rotation.
- 95 to 1 worm gear drive and long handle provide easy engine rotation.
- Floor lock keeps stand from moving during repairs.
- Universal adapter included.
- Optional adapters available.

GEAR-DRIVEN 360° ROTATION MAKES FOR EASIER REPAIRS

MODEL NUMBER	CAPACITY	OVERALL DIMENSIONS			WHEEL DIAMETERS		ROTATIONAL CLEARANCE FROM MTG. HEAD TO GROUND	SHIPPING WEIGHT
		Length	Width	Height	Front	Rear		
78160	3 Ton	54.25"	50"	45"	7"	5.75"	35.25" to 43.25"	631 lbs.

OPTIONAL ENGINE AND TRANSMISSION MOUNTING ADAPTERS



<p>78162 65 lbs.</p> <p>Detroit Diesel Engine Adapter for 53, 71, and 92 Series Engines.</p>	<p>78163 53 lbs.</p> <p>Cummins Engine Adapter for a Wide Range of Cummins Engines Including: NH, NTC, NTE, N14 855, V6 378; 504, 555, and V8 903; In-Line 6 KT 1150M. L10 (Now ISL).</p>	<p>78164 77 lbs.</p> <p>Caterpillar Engine Adapter for In-Line 6 models: 1673, 1674, 1693, 3306, & 3406 engines. V8 models: 1100, 3208, and 3408.</p>
<p>78165 66 lbs.</p> <p>IH and Ford Engine Adapter for International Harvester engines: DT-466 In-Line 6 DV-550, MV-404, MV-446, V304, V435, V392, 4-152, 4-194, 4-196, 9.0 liter V8. Ford 6.9L and 7.3L Engines.</p>	<p>78166 56 lbs.</p> <p>Mack Engine Adapter for the following In-Line Six Cylinder Engine Series: 672, 673, 675, 711.</p>	<p>78167 27 lbs.</p> <p>Detroit Allison Transmission Adapter for AT, MT, VS, VH, and V730.</p>
<p>78168 55 lbs.</p> <p>Detroit Diesel Engine Adapter for V6 and V8, Series 71 Engines.</p>	<p>78169 48 lbs.</p> <p>Caterpillar Engine Adapter for 3114, 3116, 3176 (Truck or Marine).</p>	<p>78170 42 lbs.</p> <p>Mack Engine Adapter for V8 1000, E6 and E7 In-Line 6 Cylinder Engines.</p>
<p>78172 50 lbs.</p> <p>Volvo Engine Adapter for TD67 (developed 1964), TD71 (developed 1984) Engines.</p>	<p>78173 63 lbs.</p> <p>Detroit Allison Transmission Adapter for HT740D, HT750, HT750CT, CLBT, CR/DR.</p>	<p>78174 63 lbs.</p> <p>Ford New Holland Adapter for 6.6L and 7.8L Engines.</p>
<p>78175 61 lbs.</p> <p>Cummins Engine Adapter for ISX15.</p>		

Visit www.norcoindustries.com for more information.



Shown with optional 78201 engine adapters.

78200A

2,000 Lbs. Capacity Engine Stand

INTENDED USE
A twin-post design capable of handling large automotive engines and small diesel engines ranging between 1,250 and 2,000 pounds.

FEATURES

- 50:1 ratio gearbox activated by hand crank easily turns the 360 degree rotating head to the desired work position.
- Two rigid wheels in back and two swivel caster wheels in front provide maximum stability and support. One locking caster wheel secures the stand in the desired work location.
- Polyurethane wheels provide protection for expensive tile and epoxy floors.
- Includes two universal mounting plates, rotating shaft, eight fully adjustable arms and all the related mounting hardware.
- Rotating shaft with mounting plate telescopes inside the post receiver for fine adjustment when mounting ends or sides of engines. Mounting plates can be adjusted 36-1/4" apart.

GEAR-DRIVEN 360° ROTATION MAKES FOR EASIER REPAIRS



78203A Shown

Optional Engine Mounting Adapters (For model 78200A)



MODEL	DESCRIPTION	WEIGHT
78201	Ford 6.0L and 6.4L Engine Adapter	31 lbs.
78202	Ford 6.2L Engine Adapter	37 lbs.
78203A	Ford 6.7L Engine Adapter	37 lbs.
78207	Ford 3.2L Diesel Engine Adapter	37 lbs.

FEATURES

- 50:1 ratio gearbox activated by hand crank easily turns the 360 degree rotating head to the desired work position.
- Fully adjustable engine mounting head.
- Two rigid wheels in back and two swivel caster wheels in front provide maximum stability and support. One locking caster wheel secures the stand in the desired work location.
- Polyurethane wheels provide protection for expensive tile and epoxy floors.
- Telescopic base locks into any one of four different positions to extend the length of the stand for added stability when required.



78125A

1,250 Lbs. Capacity Engine Stand

INTENDED USE
For safe handling and positioning of automotive engines weighing up to 1,250 pounds.



78127

Ford 6R60, 6R75, 6R80, 10R60 & 10R80 Transmission Adapter

INTENDED USE
Rotating transmission adapter for use with model 78125A and 78200A engine stands. Weight: 30 lbs.

MODEL NUMBER	CAPACITY	HEIGHT	WIDTH		LENGTH		SHIPPING WEIGHT
			Front	Rear	From	To	
78125A	1,250 lbs.	42"	21.25"	40"	38.25"	53.25"	179 lbs.
78200A	2,000 lbs.	42"	21.25"	40"	38.25"	53.25"	289 lbs.

78100 
IMPORT 78100i
1,000 Lbs. Capacity Engine Stand

INTENDED USE
 For safe handling and positioning of most automotive engines.

- FEATURES (78100 / 78100i)**
- Fully adjustable engine mounting head.
 - Long handle and 360 degree rotating head easily position engine.
 - One bolt disassembles stand for transporting or storage.
 - Heavy wall tubing prevents excessive frame flex.
 - 2 rigid wheels in back and 2 swivel caster wheels in front provide maximum stability and support.



A CHOICE OF USA MADE OR IMPORT STANDS

78108 
IMPORT 78108i
1,250 Lbs. Capacity Engine Stand

INTENDED USE
 Same as models 78100 and 78100i but with heavier construction to handle the largest V8s.



- FEATURES (78108 / 78108i)**
- Same as the models 78100 and 78100i but with upgraded wheels which include locking front caster wheels.
 - Four bolts disassemble stand for transporting or storage.

OPTIONAL EQUIPMENT

78109 
Transmission Adapter
 replaces engine mounting fingers and converts engine stand into a transmission service stand.
 Weight: 11 lbs.



MODEL NUMBER	CAPACITY	OVERALL DIMENSIONS			FINGER ADJUSTMENT		SHIPPING WEIGHT	
		Length	Width	Height	Height	Width		
78100	78100i	1,000 lbs.	37"	34.5"	38"	12"-15.5"	15"-18"	87 lbs.
78108	78108i	1,250 lbs.	39"	36.5"	39"	12"-15.5"	15"-18"	115 lbs.

ENGINE LOAD LEVELERS

INCREASE TECHNICIAN SAFETY BY LEVELING THE LOAD

78115
1,500 Lbs. Capacity Engine Load Leveler

INTENDED USE
 Designed to attach to a crane to position automobile and light truck engines and other vehicle components.

- FEATURES**
- Designed to hook to a crane or hoist to handle and position large, bulky components.
 - The horizontal tilt can be adjusted to compensate for off-center loads, or adjusted to a certain angle for a component being positioned.
 - Large adjustment handle allows for quick and easy leveling of the load.
 - Can be used with NORCO Model 78106A Engine Crane.



78606 
6,000 Lbs. Capacity Engine Load Leveler

INTENDED USE
 Designed to attach to a crane to position heavy duty truck engines and other vehicle components.

- FEATURES**
- Designed to hook to a crane or hoist to handle and position large, bulky components.
 - The horizontal tilt can be adjusted to compensate for off-center loads, or adjusted to a certain angle for a component being positioned.
 - Adjustment screw can be used manually or with air tools.
 - Can be used with NORCO Model 78600B or 78605A Engine Cranes.
 - 5/16" Alloy Grade 80 chain.
 - Position of hooks adjusts from 32" to 48".

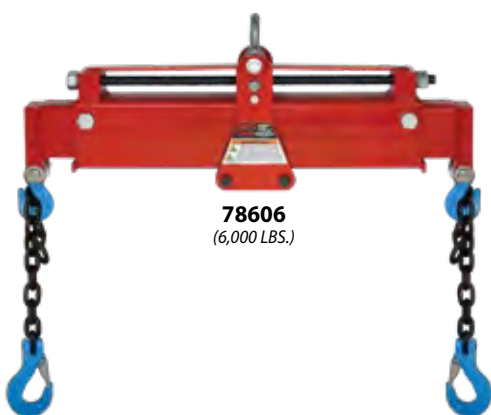

MODEL NUMBER	CAPACITY	OVERALL DIMENSIONS			CHAIN LENGTH	SHIPPING WEIGHT
		Length	Width	Height		
78115	1,500 lbs.	28.25"	2.375"	8.125"	27"	20 lbs.
78606	6,000 lbs.	32.187"	5"	15.625"	26.875"	69 lbs.

DESIGNED AND BUILT IN AMERICA

FEATURES

- Four position telescopic boom with 3/8" proof chain and hook.
- 3 ton capacity hydraulic power unit provides faster raising action and a large diameter ram to withstand angle loads.
- Low profile design (4-3/4" from top of legs to ground) allows positioning under low ground clearance vehicles.
- Quick foldable legs and boom save shop space (22-1/2" x 51-3/4") and prepare crane for transport or storage within seconds.
- 4" diameter front wheels and locking rear caster wheels provide positive steering and easy maneuvering. Locking caster wheels secure crane from moving when in use.



FEATURES

- Four position telescopic boom that folds down for traveling position or storage.
- 5 to 1 gear ratio winch with 20 foot long 1/4" diameter steel cable and hook pulls the load toward the boom.
- Winch gear design acts as a brake and allows the load to be lowered incrementally if desired and without the need for constant hand pressure against the crank handle.
- Hydraulically activated boom lifts the load to the desired height.
- Crane swivels 360 degrees but can be locked in position.

TRUCK CRANE

78204A 
1/2 Ton Capacity Truck Crane

INTENDED USE
 Same as the model 78106A but mounts in the bed of a truck or on a loading dock.

FEATURES

- Multiple boom positions and leg extensions ranging from 49" to 81" provide maximum stability.
- Boom swivels 10 degrees right or left if base cannot be centered under the load.
- Floor lock secures crane from moving when in use.
- Model 78600B includes a foot activated air/hydraulic foot pump requiring 100 P.S.I. air pressure.
- Model 78605A includes an electro/hydraulic pump requiring 115 VAC.



NOTE:
 See information concerning air and electro/hydraulic pumps on page 39.

*Model not shown has same basic construction as model pictured.

FLOOR CRANE

78600B 
3 Ton Capacity Air / Hydraulic Floor Crane

78605A 
3 Ton Capacity Electro / Hydraulic Floor Crane

INTENDED USE
 For lifting heavy items including removal and installation of diesel engines and often their transmissions.

MODEL NUMBER	BOOM CAPACITY @ LENGTH	BOOM HEIGHT		OVERALL DIMENSIONS			SHIPPING WEIGHT
		Min.	Max.	Height	Width	Length	
78106A	2,500 lbs. @ 43"	0"	88"	70.75"	51.75"	74.5"	320 lbs.
78204A	1/2 Ton @ 46.25"	0"	68.5"	64"	14"	46.25"	180 lbs.
78600B	3 Ton @ 65"	13"	149.5"	90.5"	51"	75"	1,150 lbs.
78605A	2 Ton @ 97"	13"	149.5"	90.5"	51"	75"	1,182 lbs.

72036D

4 Ton Capacity

INTENDED USE
A jack with a low enough profile to raise forklifts.

TWO-POSITION SADDLE @ SCISSORS END



SERRATED SADDLE LIFTS FLAT SURFACES



ROUNDED CUTOUT LIFTS EDGED SURFACES

INNOVATIVE LIFTING POINTS

FEATURES

- Serrated saddle which handles flat surfaces can be rotated out of the way so edged surfaces can be raised in the rounded lift arm cutout.
- 30" removable handle for ease of pumping and storage when not in use.
- Our "fingertip control" release knob provides slow, controlled, lowering of the load.
- Safety bypass and overload systems prevent cylinder damage and prevent the jack from being used beyond the ASME/PASE load-limiting standard.



MODEL NUMBER	CAPACITY	LIFT HEIGHT		OVERALL DIMENSIONS		SHIPPING WEIGHT
		(Saddle) Low	(Cutout) High	Length	Width	
72036D	4 Ton	2.5"	16.5"	30.25"	8.375"	77 lbs.

ENGINE SUPPORT TOOL

INEXPENSIVE HIGH QUALITY ENGINE SUPPORT

78099

700 Lbs. Capacity 4-Point Engine Support Tool

INTENDED USE
The main transverse support bar mounts on the shock strut towers to support engines. Heavier engines can be supported by using one or both front support adapters on the transverse support bar. Weight: 52 Lbs.



FEATURES

- Fully adjustable strut tower mounts can be positioned on the transverse support bar up to 47-1/2" apart to fit most vehicles.
- Two front support adapters can mount directly onto the transverse support bar and easily be adjusted to fit most engine compartment configurations.
- Support bar and adapters are made of lightweight steel tubing, welded together in a parallel configuration to prevent flexing and provide full length positioning of the hooks and adapter front mounting feet.
- Three 1/2" diameter hooks 14" long and spin knobs provide strength and quick adjustment to support the engine.



78090A

3600 Lbs. Capacity Car Dolly

INTENDED USE
For easy movement of vehicles that have been rendered inoperable due to engine / transaxle removal or other mechanical problems. Frees up lifts and floor jacks for other work to be performed. Used in automobile repair, collision repair, and vehicle inspection applications.



FEATURES

- Supports a vehicle with or without tires.
- Allows FWD vehicle to be easily moved in the service bay when drive train has been removed.
- Universal design fits any car without the need for additional vehicle adapters.
- Quick and independent width and height adjustments. Fully adjustable outriggers to fit any vehicle frame width. Threaded lift saddles with rubber pads are independently adjustable and provide maximum frame protection.
- Does not require installation to the subframe or engine/transaxle cradle mounting holes.
- Can be used in pairs for maximum maneuverability in tight places.
- Four 6" diameter ball bearing mounted swivel caster wheels rated at 900 pounds capacity each.
- Two of the four 6" wheels have wheel locks to prevent dolly from moving.

NO TIRES? NO PROBLEM.

MODEL NUMBER	CAPACITY	HEIGHT ADJUSTMENT	WIDTH	LENGTH ADJUSTMENT	SHIPPING WEIGHT
78090A	3,600 lbs.	12.75" to 15.75"	17"	30" to 60"	65 lbs.

SMOOTH AND EASY OPERATION

MECHANICAL SCISSORS JACK

82002C

1-1/2 Ton Capacity Scissors Jack

INTENDED USE
Passenger car tire changing.



FEATURES

- Combination right and left hand threaded drive screw for faster rising.
- Includes 2-piece extra long 22.5" crank handle for easier operation under load, longer reach and convenient storage when not in use.

MODEL NUMBER	CAPACITY	LIFT HEIGHT		BASE DIMENSIONS	SADDLE SIZE	SHIPPING WEIGHT
		Low	High			
82002C	1-1/2 Ton	3.75"	13.25"	4.25" x 7.375"	2" x 5.125"	10 lbs.

BRAKE DRUM HANDLER

72040B

Brake Drum Handler

INTENDED USE
Designed for removing, installing and transporting outboard mounted brake drums and inboard mounted drums with disc wheel hubs.

FEATURES

- Reduces lost-time injuries.
- Handles 15" and 16-1/2" drums.
- 35-1/2" handle for easy positioning during installation & removal.
- Rotating handle provides ease of raising and lowering drum.
- 8" diameter ball bearing wheels, semi-pneumatic tires and 3/4" diameter axle provide easy maneuverability and balance of drum.
- Adjustable angle bracket secures both outboard and inboard mounted drums with disc wheel hubs to the drum handler's carriage.
- Detachable handle for convenient storage.

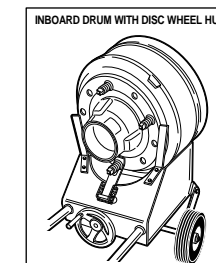
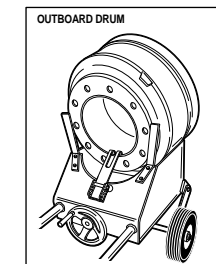

HANDLES INBOARD AND OUTBOARD DRUMS

MODEL NUMBER	LIFT HEIGHT		OVERALL DIMENSIONS		SHIPPING WEIGHT
	Low	High	Length	Width	
72040B	10.25"	15.25"	62.5"	21"	64 lbs.

2, 3, 5, 8, 12-1/2, 22, 35, & 60 Ton Capacity Bottle Jacks

INTENDED USE

For heavy duty truck, agriculture, construction, mining, mobile home, oil field, automotive, and marine applications where lifting, pushing, spreading, bending, pressing, or straightening are required.

1-1/2 & 3 Ton Capacity Long Hand Jacks

INTENDED USE

Various farm applications, but primarily used as original equipment for manufacturers of shop cranes, lift tables and any equipment requiring a long hydraulic stroke.



FEATURES

- Two piece zinc plated handle.
- Prevent rust with "Parkerized" pump piston, ram and extension screw.
- No leak "Uniweld" construction.
- 50% safety overload factor.
- State-of-the-art design reduces repair time.
- Longer wear life due to internally machined oil passages, smooth bearing surfaces and close tolerances.
- Lightweight forged base provides more steel only where strength is required.
- The heavy-duty extension screw and release valve were designed to eliminate parts and reduce the chance of breakage and excessive wear.
- Safety bypass and overload systems prevent cylinder damage and prevent the jack from being used beyond the ASME/PASE load-limiting standard.

ADDITIONAL FEATURES 12-1/2 and 22 TON CAPACITY

- "G" models are designed with a removable plug so a gauge can be adapted to the jack. (See page 30 for model 78021 gauge.)

35 and 60 TON CAPACITY

- All other features excluding extension screw.

LONG HAND JACK FEATURES

- Same as bottle jack features but designed with larger hydraulic units and larger ram diameters to withstand side loads.
- Larger diameter pump pistons for faster rising action.
- "Parkerized" rams and flash chromed pump pistons inhibit rust.

MODEL NUMBER	CAPACITY	LIFT HEIGHT		STROKE	SCREW EXTENSION	BASE SIZE	CARRY HANDLE	SHIPPING WEIGHT
		Low	High					
76502B	2 Ton	7.13"	14.5"	4.94"	2.44"	3.5" x 4.13"	No	6 lbs.
76503B	3 Ton	7.5"	15.56"	5.25"	2.81"	4" x 4.56"	No	8 lbs.
76505B	5 Ton	9.06"	18.88"	6.69"	3.13"	4.88" x 4.45"	No	11.5 lbs.
76508B	8 Ton	9.06"	18.75"	6.5"	3.19"	5.38" x 5.13"	Yes	14 lbs.
76412B 76412BG	12.5 Ton	9.45"	18.9"	5.91"	3.54"	5.51" x 5.51"	Yes	18 lbs.
76512B 76520BG	12.5 Ton	6.69"	13.19"	3.74"	2.76"	5.51" x 5.51"	Yes	15 lbs.
76520B	22 Ton	10.83"	20.2"	6.61"	2.76"	6.57" x 6.06"	Yes	31 lbs.
76820B	22 Ton	8.27"	14.96"	3.94"	2.76"	6.57" x 6.06"	Yes	25 lbs.
76535	35 Ton	11"	17.38"	6.31"	--	5.63" x 7.56"	Yes	42 lbs.
76560	60 Ton	12"	18.75"	6.69"	--	7.44" x 9.31"	Yes	82 lbs.
LONG HAND JACKS								
76402B	1.5 Ton	22.6"	41.9"	19.3"	--	4" x 4.56"	No	17.5 lbs.
76403B	3 Ton	24"	43.5"	19.5"	--	4.88" x 4.45"	No	24 lbs.

**76312B
12 Ton Capacity Standard Height**

INTENDED USE

For use in heavy duty trucks, farm equipment, building construction, construction and mining equipment, mobile home set-up and oil field applications.



MORE QUALITY FEATURES IN A UNIQUE DESIGN

FEATURES

- Fast efficient air pump reduces lifting time and has a built-in relief mechanism which prevents the jack from being used beyond its maximum allowable capacity.
- Convenient push button air valve connected to an in-line filter prevents contaminants from entering the air/hydraulic system.
- Unique design allows for manual operation when air is not available.
- Two piece zinc plated handle.
- Parkerized coating on pump piston, extension screw and extension adapters and chrome coated ram offer protection against rust.
- Longer wear life due to internally machined oil passages, smooth bearing surfaces and close tolerances.
- Safety bypass and overload systems prevent cylinder damage and prevent the jack from being used beyond the ASME/PASE load-limiting standard.
- Carrying handle.

MODEL NUMBER	CAPACITY	LIFT HEIGHT		STROKE	SCREW EXTENSION	BASE SIZE	P.S.I. RANGE	SHIPPING WEIGHT
		Low	High					
76312B	12 Ton	9.63"	19.75"	6"	4"	6.63" x 8"	100-130	24 lbs.
76320B	20 Ton	10.88"	20.5"	6.75"	2.75"	6.44" x 9"	100-130	41 lbs.
76720B	20 Ton	8.25"	14.5"	4"	2.25"	6.44" x 9"	100-130	36 lbs.
76721A	20 Ton	7.75"	11.75"	4"	N/A	6.44" x 9"	100-130	36 lbs.



**76320B
20 Ton Capacity Standard Height**

INTENDED USE

For use in heavy duty trucks, farm equipment, building construction, construction and mining equipment, mobile home set-up and oil field applications.

**76720B
20 Ton Capacity Low Height**

INTENDED USE

For use in heavy duty trucks, farm equipment, building construction, construction and mining equipment, mobile home set-up and oil field applications.

**76721A
20 Ton Capacity Ultra Low Height**

INTENDED USE

Made specifically for automobile haulers that use trailers that are very low to the ground. "Car haulers love our jacks!"

WELDED FRAME MEANS NO ASSEMBLY REQUIRED

78013B
12-1/2 Ton Capacity Hand Pump Operated

78022E
22 Ton Capacity Hand Pump Operated

INTENDED USE
 Straightening, bending & pressing. Removing and installing gears, bearings and bushings.

FEATURES

- Welded frame, fully assembled, tested, and ready to put to work.
- Manual pump power unit with "Parkerized" pump piston, ram and extension screw to inhibit rust from entering the hydraulic system.
- Pair of bed plates included.
- Shielded heavy duty ram return springs.
- Power unit is bearing mounted for horizontal movement on head channel.
- Zero distortion, heavy duty structural steel frame.
- Optional equipment below can be used on model 78022E press. Model 78033 arbor plates and model 78032 bearing puller below can be used on model 78013B press.



78024
(25 TON)

FEATURES

- Welded frame, fully assembled, tested, and ready to put to work.
- Air/hydraulic foot pump provides hands free operation.
- **Note:** See page 38 for additional information on the model 910130A pump.
- Pair of bed plates included (Model 78033).
- Self-retracting ram can slide for horizontal movement on head channel.
- Zero distortion, heavy duty structural steel frame.
- Liquid filled gauge measures ram force and internal working pressure.
- Optional equipment, Model 78025 Accessory Kit can be used on this press. (see below)

NOTE:
 Model not shown has same basic construction as model pictured.



78013B
(12-1/2 TON)
78022E (shown)
(22 TON)

78024
25 Ton Capacity Air / Hydraulic Pump Operated

INTENDED USE
 Straightening, bending & pressing. Removing and installing gears, bearings and bushings.

MODEL NUMBER	CAPACITY	RAM TRAVEL	THROAT HEIGHT		THROAT WIDTH	BED HEIGHT ADJUSTMENTS	BETWEEN UPRIGHTS	BETWEEN BED RAILS	BASE		OVERALL HEIGHT	SHIPPING WEIGHT (Lbs.)
			MIN.	MAX.					WIDTH	DEPTH		
78013B	12.5 Ton	5.875"	5"	38.25"	25"	8 x 4.75"	5"	6"	34"	28"	70.625"	266
78022E	22 Ton	6.625"	7.125"	35.5"	30"	7 x 4.75"	6"	7"	40"	28"	70.625"	394
78024	25 Ton	8"	6.75"	40"	30.5"	8 x 4.75"	6"	7"	40"	28"	76.75"	430

OPTIONAL EQUIPMENT:

78025
Accessory Kit for 20, 22 & 25 Ton Capacity Shop Presses
 Weight: 40 lbs.

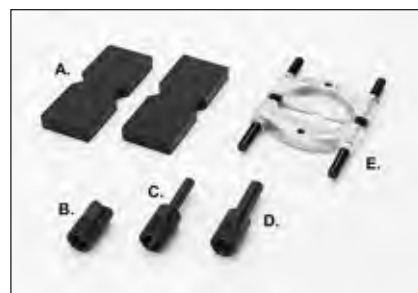

INCLUDES:

- A. MODEL 78033 - Arbor Plates
- B. MODEL 78028 - "V" Pushing Adapter
- C. MODEL 78029 - 3/4" Diameter Ram
- D. MODEL 78031 - 1" Diameter Ram
- E. MODEL 78032 - Bearing Puller

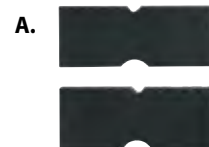

A. 78033

Arbor Plates
 A pair of 1" x 4" x 10" long steel plates with "V" cutout on one edge and circle cutout on the other. For 12, 12-1/2, 20, 22 & 25 ton capacity presses only.
 Weight: 28 lbs.



78021

Hydraulic Gauge w/ Fittings

4" Diameter face designed to work with NORCO 12, 12-1/2, 20 & 22 ton presses.
 Weight: 2 lbs.

WELDED FRAME MEANS NO ASSEMBLY REQUIRED

78055A

50 Ton Capacity 2-Speed Hand Pump Operated

INTENDED USE

Heavy duty use in truck garages and industrial workshops.

78057A

6.25" Stroke w/ 910130A Air/Hyd. Pump

78077

13.25" Stroke w/ 910140 Air/Hyd. Pump

50 Ton Capacity Air / Hydraulic Pump Operated

INTENDED USE and FEATURES

Same as model 78055A but equipped with an air/hydraulic foot pump and model 910036A 10' hose.

Note: See pages 38 & 39 for additional information on pumps.

78058A

6.25" Stroke w/ 910052A Electro/Hydraulic Pump

78078

13.25" Stroke w/ 910052A Electro/Hydraulic Pump

50 Ton Capacity Electro / Hydraulic Pump Operated

78110C

10.25" Stroke w/ 910019B Electro/Hydraulic Pump

100 Ton Capacity Electro / Hydraulic Pump Operated

INTENDED USE

Heavy duty use in truck garages and industrial workshops.

Note: See page 39 for additional information on pumps.



78055A (50 TON)
78057A (50 TON)
78077 (50 TON)
78058A (50 TON)
78078 (shown) (50 TON)
78110C (100 TON)

NOTE:
 Models not shown have same basic construction as model pictured. Individual photos and details on www.norcoindustries.com

OPTIONAL EQUIPMENT:

78060

Accessory Kit for 50 Ton Capacity Shop Presses

Weight: 147 lbs.

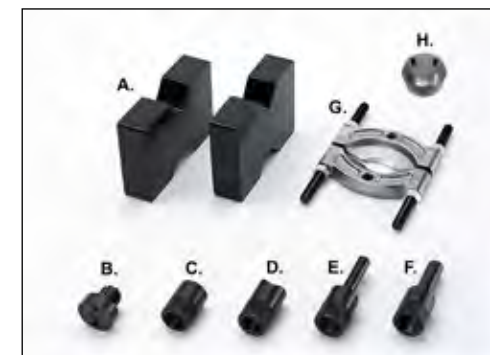

A. 78056A

50 Ton Capacity Pair of Arbor Plates
 used with all 50 ton capacity presses. Weight: 108 lbs.

78111A

100 Ton Capacity Pair of Arbor Plates
 used with model 78110C shop press. Weight: 153 lbs.

INCLUDES:

- A. MODEL 78056A - Arbor Plates
- B. MODEL 78059 - Threaded Adapter
- C. MODEL 78061 - Ram Cap
- D. MODEL 78062 - "V" Pushing Adapter
- E. MODEL 78063 - 1" Diameter Ram
- F. MODEL 78064 - 1-1/4" Diameter Ram
- G. MODEL 78066 - Bearing Puller
- H. MODEL 45100453 - Adapter

MODEL NUMBER	CAPACITY	RAM TRAVEL	THROAT HEIGHT		THROAT WIDTH	BED HEIGHT ADJUSTMENTS	BETWEEN UPRIGHTS	BETWEEN BED RAILS	BASE		OVERALL HEIGHT	SHIPPING WEIGHT
			MIN.	MAX.					WIDTH	DEPTH		
78055A	50 Ton	6.25"	7.5"	32.625"	34.5"	7 x 5"	5.625"	7.375"	50"	40"	72.75"	804 lbs.
78057A	50 Ton	6.25"	7.5"	32.625"	34.5"	7 x 5"	5.625"	7.375"	50"	40"	72.75"	801 lbs.
78058A	50 Ton	6.25"	7.5"	32.625"	34.5"	7 x 5"	5.625"	7.375"	50"	40"	72.75"	814 lbs.
78077	50 Ton	13.25"	7.5"	32.625"	34.5"	7 x 5"	5.625"	7.375"	50"	40"	72.75"	833 lbs.
78078	50 Ton	13.25"	7.5"	32.625"	34.5"	7 x 5"	5.625"	7.375"	50"	40"	72.75"	846 lbs.
78110C	100 Ton	10.25"	18.25"	45.75"	40.25"	8 x 4.5"	5.625"	9"	58"	40"	81"	1,777 lbs.

IMPORT 82999Ai

10 Ton Capacity

INTENDED USE

Truck and farm equipment dealer garages, heavy duty construction repair shops and bus company garages.



FEATURES

- Three-way heavy duty air valve provides fine control when lifting or lowering a vehicle.
- Automatic safety lock engages in six different height positions independent of air pressure.
- Designed for lifting entire front or rear of a vehicle.
- Front swivel caster wheel and two 12-1/4" diameter pneumatic rear tires provide easy maneuverability.
- Adjustable lifting saddles can be raised and extended to desired position.

INTERNAL LOAD DAMPENING SAFETY DEVICE

MODEL NUMBER	CAPACITY @200 P.S.I.	LIFT HEIGHT		OVERALL DIMENSIONS			SADDLE REACH	SHIPPING WEIGHT
		Low	High	Length	Width	Height		
82999Ai	10 Ton	12.83"	44.72"	40.59"	34.72"	67.75"	11.18"	817 lbs.

LONG REACH AIR LIFT JACK

82995



8-1/2 Ton Capacity

INTENDED USE

For truck, bus, farm equipment and motor home applications where a long reach jack is required to lift at the vehicle bumper, frame or front axle.



LONGEST REACH IN THE INDUSTRY

FEATURES

- Three-way heavy duty air valve provides fine control when lifting or lowering a vehicle.
- Automatic safety lock engages in five different height positions independent of air pressure.
- Includes extension tubes and adjustment pins for added height requirements.
- Two 10" diameter solid wheels are strategically located for better positioning and maneuverability.
- Scissors action frame design with four 5" diameter steel wheels provides maximum stability during lifting and lowering.
- Large air cylinder requires only 100 p.s.i. air pressure to lift 5 ton capacity.
- Over four feet of reach between cylinder and center line of lifting saddle.

MODEL NUMBER	CAPACITY	LIFT HEIGHT		OVERALL DIMENSIONS			SADDLE REACH	SHIPPING WEIGHT
		Low	High	Length	Width	Height		
82995	5 Ton @ 100 P.S.I. 7 Ton @ 150 P.S.I. 8-1/2 Ton @ 180 P.S.I.	10"	50"	80.5"	38"	53.75"	50"	935 lbs.

PERFECT FOR LIFTING TRAILERS

82990C

10 Ton Capacity

INTENDED USE

Garages / repair shops of truck, farm equipment, construction equipment and bus companies. May be used in pairs. Ideal for crowded conditions that require single point contact.



FEATURES

- Three-way heavy duty air valve provides fine control when lifting or lowering a load.
- Extension tubes and detent pins offer multiple lifting heights.
- Unit easily maneuvered on two 8" diameter rubber tread wheels.
- Removable handle and 8' air hose for remote safe positioning and operation.
- Lifting saddle with serrated surface and locating lugs.



Serrated Saddle

MODEL NUMBER	CAPACITY @172 P.S.I.	LIFT HEIGHT		OVERALL DIMENSIONS			STROKE	SHIPPING WEIGHT
		Low	High	Length	Width	Height		
82990C	10 Ton	17.75"	49.375"	58"	13.625"	17.75"	11.5"	178 lbs.

BEST FOR AG EQUIPMENT APPLICATIONS

82992

15 Ton Capacity

INTENDED USE

Garages / repair shops of truck, farm equipment, construction equipment and bus companies. May be used in pairs. Ideal for crowded conditions that require single point contact.



FEATURES

- Three-way heavy duty air valve provides fine control when lifting or lowering a load.
- Extension tubes and detent pins offer multiple lifting heights.
- Unit easily maneuvered on two 8" diameter rubber tread wheels.
- Removable handle and 8' air hose for remote safe positioning and operation.
- Lifting saddle with and locating lugs.

MODEL NUMBER	CAPACITY @186 P.S.I.	LIFT HEIGHT		OVERALL DIMENSIONS			STROKE	SHIPPING WEIGHT
		Low	High	Length	Width	Height		
82992	15 Ton	18.125"	51.375"	59.5"	15"	18.125"	11.25"	240 lbs.

79324G

3 Ton Capacity Air / Hydraulic Pump Operated Rolling Lift Bridge

NOTE: To achieve maximum lifting capacity, the lifting surface must be raised at least 3.25" higher than its lowest point.

INTENDED USE

Used in quick lube pit applications or in conjunction with above ground lifts. The bridge straddles the lift rails and raises the vehicle's tires off the rails for wheel alignment, brake, tire and suspension work.



FEATURES

- Push button air/hydraulic pump provides safe, quick lifting up to 9".
- The lifting pads safely support the vehicle on the bridge and the adjustable lift arms span up to 62-1/2".
- Universal mounting brackets adjust to a lift rail opening of 46-1/2".
- Flat-end and hook-end adapter brackets are equipped with spring-loaded roller bearings for smooth maneuverability of bridge on lift rails. These brackets are sold separately.
- Mechanical stop prevents accidental lowering of bridge.
- Lowering is accomplished with one hand on the release lever and the other hand releasing the mechanical stop.
- Equipped with rubber faced saddle for differential lifting.
- Included lift adapters: (2) 3-1/2" Adapters, (2) 5" Adapters, and (2) Padded Saddles w/ Extension Screws

UNIQUE COMBINATION OF ADAPTERS ALLOWS USE ON MOST DRIVE-ON FOUR-POST LIFTS OR QUICK-LUBE PITS

NOTE:

Adapter bracket kits must be ordered separately to adapt the universal mounting brackets to the above ground lift's rails. The majority of applications will require model 79326D flat-end or model 79327D hook-end adapter kits.



79326D
SOLD IN KITS

79327D
SOLD IN KITS

MODEL NUMBER	CAPACITY @ 100 P.S.I.	STROKE	ADAPTER HEIGHTS				DIMENSIONS			SHIPPING WEIGHT
			Saddle Retracted	Saddle Extended	Short Adapter	Tall Adapter	Length	Width	Height	
79324G	3 Ton	9"	1.25"	3.5"	3.5"	5"	40.25" to 62.5"	21.5"	9.375" to 18.375"	325 lbs.

79326D

Flat-End Adapter Bracket Kit

Enables the Rolling Lift Bridge to roll on flat surfaces. Weight: 12 lbs. per set of 4.

79327D

Hook-End Adapter Bracket Kit

Enables the Rolling Lift Bridge to roll on the rails of the lift. Weight: 12 lbs. per set of 4.

PORTABLE MID-RISE LIFT

86002A

55" Mid-Rise Lift 6,000 Lbs. Capacity

INTENDED USE

Lifts cars, vans and light-duty trucks for wheel and brake related repairs, tire and wheel changing, collision repair work and new car preparation.



FEATURES

- Portable trolley supports the pump and maneuvers the lift from one service bay to another.
- Twin hydraulic cylinders and scissors lift design provide maximum support and stability.
- Hydraulic velocity fuses allow slow release of lift in the event of hose or hydraulic component damage.
- 4-1/2" low height for easy drive on and off.
- Fast and efficient operating pump powered by a 1 hp, 115 volt motor (1 year warranty on pump and motor).
- Sliding radius arms easily adjust to vehicle frame lift positions.
- Automatic mechanical safety lock will lock in a 24-1/2", 31", 36-3/4", 42-1/8", 46-1/2", 50-3/4", or 55" lift height.
- 12" hydraulic hose & 12-1/2" release cable.

MODEL NUMBER	CAPACITY	OVERALL DIMENSIONS		LIFT HEIGHT		SHIPPING WEIGHT
		Length	Width	Low	High	
86002A	6,000 lbs.	96.5"	39.75"	5.5"	55"	965 lbs.

PORTABLE LIFTING FOR PROFESSIONAL OR D.I.Y.

86010A

Extension Adapters



For higher frame clearance vehicles. Includes four 4-1/2" extension adapters for use with swivel rubber lifting pads included with the 86002A. Weight: 18 lbs.

MULTIPLE PRICE POINTS WITH CAST OR FORGED STEEL ADAPTERS

FEATURES

- Pump gauge included to enable pump user to know tonnage being applied.
- "Quick-Lock" design for fast and easy assembly and disassembly.
- Long handle provides ease of pumping.
- Thick walled extension tubes for added strength and longer life.
- Roto-molded plastic case for organized component storage and ease of carrying.
- Flexible hydraulic hose with spring guards at both ends.
- Forged steel adapters for added strength and durability (904004C/910005C).
- All casting parts are made of nodular cast iron (904005B/910006B).

Kit Weight:
904004C: 41 lbs.
904005B: 42 lbs.



CAUTION!



When cylinders are used w/ maintenance set attachments or components, the maximum system pressure must be limited to half the rated pressure (5,000 P.S.I.).

FEATURES

- All the same features found in the 4 ton kits.
- Kit Weight:**
910005C: 83 lbs.
910006B: 77 lbs.



4 Ton Kits Include:

- PLASTIC CASE
- 10,000 P.S.I. PUMP w/ GAUGE
- 6' HOSE
- 4" STROKE RAM
- WEDGE RAM (1/2 TON CAP.)
- 4", 8", 12" AND 16" EXTENSION TUBES
- TUBE CONNECTOR
- SERRATED SADDLE
- RUBBER HEAD
- WEDGE HEAD
- RAM TOE
- PLUNGER TOE
- RUBBER FACED FLAT BASE
- 90 DEGREE "V" BASE

904004C (shown)
*904005B
(4 TON)

10 Ton Kits Include:

- WHEELED PLASTIC CASE
- 10,000 P.S.I. PUMP w/ GAUGE
- 6' HOSE
- 6" STROKE RAM
- WEDGE RAM (1/2 TON CAP.)
- 5", 10", 14" AND 19" EXTENSION TUBES
- TUBE CONNECTOR
- SERRATED SADDLE
- RUBBER HEAD
- WEDGE HEAD
- 90 DEGREE "V" BASE
- FLAT BASE
- RAM TOE
- PLUNGER TOE

910005C (shown)
*910006B
(10 TON)

904004C

4 Ton Capacity Kit (Forged Adapters)

904005B

4 Ton Capacity Kit (Cast Adapters)

INTENDED USE

For collision repair, industrial and construction applications where convenience of hydraulic power can be utilized for spreading, clamping, pushing and lifting operations.

NOTE: Cast & forged adapter components vary in size and are not interchangeable.

910005C

10 Ton Capacity Kit (Forged Adapters)

910006B

10 Ton Capacity Kit (Cast Adapters)

INTENDED USE

Same as 4 ton kits but for heavier jobs such as automotive frame straightening.

NOTE: Cast & forged adapter components vary in size and are not interchangeable.

920020A

20 Ton Capacity Kit (Forged Adapters)

INTENDED USE

A deluxe kit for repairing heavy road machinery, trucks, farm equipment and also used for some heavy construction applications.

Model 920020A Kit Includes:

- STEEL CASE (1 OF 2)
- 2-SPEED PUMP w/ GAUGE
- 5' HOSE
- RAM, 5" STROKE
- 3-1/2" DIA. SADDLE (2)
- THREADED COUPLER (3)
- TOE LIFT
- WEDGE HEAD
- VEE HEAD
- STEEL CASE (2 OF 2)
- 3" EXTENSION TUBE (2)
- 5" EXTENSION TUBE
- 10" EXTENSION TUBE
- 20" EXTENSION TUBE
- 27-1/2" EXTENSION TUBE
- 6-1/2" DIA. BASE (2)



HEAVY DUTY CYLINDERS
DESIGNED IN THE U.S.A.

INTENDED USE

For many applications including shop, agricultural, automotive / truck service needs and construction maintenance applications where lifting, pushing, pulling, bending or holding may be required.

SINGLE-ACTING CYLINDER FEATURES

- High flow quick connecting coupler and dust cap included on all models.
- Unique piston and cylinder bearings absorb eccentric load stresses in order to protect the cylinder against abrasion, over-extending and jamming.
- Nickel plating on most cylinder pistons inhibits rusting.
- Baked enamel exterior finish for increased corrosion resistance.
- Polyurethane seals and wipers provide high cycle life.
- Heavy duty return springs provide consistent performance.
- Cylinders comply with ANSI B 30.1.

DOUBLE-ACTING CYLINDER FEATURES

- Same as the standard cylinders but have the ability to pull as well as push under power.
- IMPORTANT: Double-acting cylinders can only be used with the 4-way valve hand pump model 925014 found on page 39.
- Built-in safety valve prevents over-pressurization.

910028A

WEDGE RAM FEATURES

- Jaws open from 3/8" to 3-11/16" so ram can be used in very confined work areas.
- Spring retractable jaws.

NOTE:
Models not shown have same basic construction as model pictured.



SINGLE-ACTING CYLINDERS

MODEL NUMBER	CAPACITY	STROKE (Inches)	OIL CAP (Cu. In.)	CYLINDER BORE DIA. (Inches)	CYLINDER EFFECTIVE AREA (Sq.In.)	RETURN SPRING	HEIGHT		OUTSIDE DIA.		THREAD SIZE		SHIPPING WEIGHT	
							Min.	Max.	Piston	Cylinder	Piston (NPT)	CYL. COLLAR (Inches x Thrd.)		INTERNAL BASE (NPT)
910026A	10 Ton	6.13	13.67	1.69	2.23	YES	12.5"	18.63"	1.5"	2.25"	1.25 x 11.5	2.25 x 14	1.25 x 11.5	10 lbs.
910027A	10 Ton	2.13	4.75	1.69	2.23	YES	4.5"	6.63"	1.5"	2.25"	---	2.25 x 14	---	6 lbs.
910029A	10 Ton	10.13	22.59	1.69	2.23	YES	16.5"	26.63"	1.5"	2.25"	1.25 x 11.5	2.25 x 14	1.25 x 11.5	14 lbs.
910030	10 Ton	12	26.76	1.69	2.23	YES	15.75"	27.75"	1.5"	2.25"	---	2.25 x 14	---	16.5 lbs.
910045	10 Ton	12	22.59	1.69	2.23	YES	16.5"	26.63"	1.5"	2.25"	1.25 x 11.5	2.25 x 14	(2) 5/16-18 x .500"	14 lbs.
910047	10 Ton	14	31.22	1.69	2.23	YES	17.75"	31.75"	1.5"	2.25"	---	2.25 x 14	---	18 lbs.
915006	15 Ton	6	18.84	2.00	3.14	YES	10.69"	16.69"	1.63"	2.75"	---	2.75 x 16	---	15 lbs.
925026B	20 Ton	1.75	7.77	2.38	4.44	YES	3.88"	5.63"	2.00"	3.63"	---	---	---	11 lbs.
925023	25 Ton	4	20.60	2.56	5.15	YES	8.5"	12.5"	2.25"	3.38"	---	3.31 x 12	---	18 lbs.
925024	25 Ton	10.25	52.79	2.56	5.15	YES	14.75"	25"	2.25"	3.38"	---	3.31 x 12	---	31 lbs.
925025A	25 Ton	6.25	32.19	2.56	5.15	YES	14.88"	21.13"	2.25"	3.38"	2 x 11.5	3.31 x 12	2 x 11.5	22 lbs.
925027A	25 Ton	14.25	73.39	2.56	5.15	YES	22.88"	37.13"	2.25"	3.38"	2 x 11.5	3.31 x 12	2 x 11.5	39 lbs.
930003	30 Ton	2.44	15.85	2.88	6.50	YES	4.63"	7.06"	2.62"	4.00"	---	---	---	15 lbs.
950005	50 Ton	2.38	22.91	3.50	9.63	YES	4.81"	7.19"	2.75"	5.00"	---	---	---	24 lbs.
955019A	50 Ton	6.25	69.06	3.75	11.05	YES	11.13"	17.38"	3.13"	5.00"	---	5 x 12	---	51 lbs.
999000	100 Ton	10.25	211.66	5.13	20.65	YES	17.69"	27.94"	4.13"	7.00"	---	6.89 x 12	---	160 lbs.

DOUBLE-ACTING CYLINDERS

MODEL NUMBER	CAPACITY (Tons)		STROKE (Inches)	OIL CAP (Cu. In.)		CYLINDER BORE DIA. (Inches)	CYLINDER EFFECTIVE AREA (Sq.In.)	HEIGHT		OUTSIDE DIA.		SADDLE DIAMETER	COLLAR THREAD SIZE	SHIPPING WEIGHT	
	Push	Pull		Push	Pull			Min.	Max.	Piston	Cylinder				
910010	10	4	10	22.33	8.00	1.69	2.23	.80	16.125"	26.13"	1.38"	2.88"	1.38"	2.25 x 14	28 lbs.
930008	30	5	8.25	53.67	25.00	2.88	6.51	3.00	15.25"	23.5"	2.13"	4.00"	2"	3.31 x 12	40 lbs.
955106	50	10	6.125	67.77	21.00	3.75	11.06	3.40	13.06"	19.19"	3.13"	5.00"	2.81"	5 x 12	67 lbs.
999106	100	48	6.625	136.93	63.00	5.13	20.65	9.60	14.06"	20.69"	3.75"	7.00"	3"	6.88 x 12	135 lbs.

WEDGE RAM

MODEL NUMBER	CAPACITY	ARM HEIGHT		OVERALL DIMENSIONS			CYLINDER AREA (Cu.In.)	OIL CAP (Cu.In.)	SHIPPING WEIGHT
		CLOSED	OPEN	HEIGHT	WIDTH	LENGTH			
910028A	1 Ton	.38"	3.69"	2.01"	2.01"	8.78"	1.00	.61	5 lbs.

HEAVY DUTY CYLINDERS
DESIGNED IN THE U.S.A.

FEATURES

- Lightweight aluminum body.
- Extremely durable.
- Ships completely assembled with coupler, shutoff, and base.
- The perfect cylinder for heavy-duty road service.
- These portable cylinders lift 50 tons with 10,000 P.S.I. hydraulic pumps.



955055

50 Ton Aluminum Ram w/ Base & Shutoff Valve

INTENDED USE
Made for lifting heavy off-road and construction equipment.

MODEL NUMBER	CAPACITY	STROKE (Inches)	OIL CAP (Cu. In.)	CYLINDER BORE DIA. (Inches)	CYLINDER EFFECTIVE AREA (Sq.In.)	RETURN SPRING	HEIGHT		OUTSIDE DIA.		SHIPPING WEIGHT
							Min.	Max.	Piston	Cylinder	
955055	50 Ton	6.25	69	3.75	11.05	YES	11.75"	18"	3.13"	6"	39 lbs.

COMPATIBILITY CHART
HYDRAULIC CYLINDERS (Page 36)

PUMPS (Pages 38-39)	910010	910026A	910027A	910028A	910029A	910030	910045	910047	915006	925023	925024	925025A	925026B	925027A	930003	930008	950005	955019A	955065	955070	955106	999000	999106	
910017B		●	●	●	●	●	●	●	●	●	●	●	●	●	●	●	●	●	●	●	●	●	●	●
910018B		●	●	●	●	●	●	●	●	●	●	●	●	●	●	●	●	●	●	●	●	●	●	●
910019B		●	●	●	●	●	●	●	●	●	●	●	●	●	●	●	●	●	●	●	●	●	●	●
910020		●	●	●	●	●	●	●	●	●	●	●	●	●	●	●	●	●	●	●	●	●	●	●
910052A		●	●	●	●	●	●	●	●	●	●	●	●	●	●	●	●	●	●	●	●	●	●	●
910130A		●	●	●	●	●	●	●	●	●	●	●	●	●	●	●	●	●	●	●	●	●	●	●
910140		●	●	●	●	●	●	●	●	●	●	●	●	●	●	●	●	●	●	●	●	●	●	●
910165		●	●	●	●	●	●	●	●	●	●	●	●	●	●	●	●	●	●	●	●	●	●	●
925009A		●	●	●	●	●	●	●	●	●	●	●	●	●	●	●	●	●	●	●	●	●	●	●
925010A		●	●	●	●	●	●	●	●	●	●	●	●	●	●	●	●	●	●	●	●	●	●	●
925011		●	●	●	●	●	●	●	●	●	●	●	●	●	●	●	●	●	●	●	●	●	●	●
925012A		●	●	●	●	●	●	●	●	●	●	●	●	●	●	●	●	●	●	●	●	●	●	●
925013B		●	●	●	●	●	●	●	●	●	●	●	●	●	●	●	●	●	●	●	●	●	●	●
925014	●																							

Note: A dot inside a square indicates there is sufficient oil in the pump to operate the cylinder to maximum extension. Although some pumps and cylinders are compatible, the useable oil capacity in both are so close that longer hoses (requiring more oil) that connect both components may prevent the pump from operating the cylinder to maximum extension.

SAFE, RELIABLE, DEPENDABLE PERFORMANCE

910017B 910018B

910130A 910140

10,000 P.S.I. Capacity Foot-Operated Pumps



910165

10,000 P.S.I. Capacity Hand-Operated Pump



INTENDED USE

For automotive / truck, industrial & construction jobs. The added convenience of an air motor reduces pumping time and effort to activate cylinders.

910017B & 910018B FEATURES

- Designed to utilize exhaust air to help power the pump, requiring only 80 P.S.I. air pressure to develop 10,000 P.S.I. hydraulic pressure.
- Air exhaust muffler for quieter operation.
- Air and oil inlet filters for reduced risk of damage from contamination.
- Designed with durable light weight, corrosion resistant plastics.
- Foot pedal provides hands free pumping and release of load.
- Designed to be used with a single-acting cylinder.
- Internal pressure relief valve for overload protection.
- Model 910018B has two-gallon capacity steel reservoir body.

910130A & 910140 FEATURES

- Same as the models 910017B and 910018B but with added features:
- The model 910130A pump is equipped with a more durable aluminum reservoir.
 - Both models 910130A and 910140 come with two different size poppit valves that can be quickly and easily installed. Poppit valves reduce the return flow of oil back to the pump's reservoir providing a safer controlled lowering of load.
 - The model 910140 pump is equipped with a thick wall aluminum extruded reservoir.

910165 FEATURES

- Same as above models, but is hand-operated and provides finer control of raising or lowering loads.

910020

3,250 P.S.I. Capacity Air / Hydraulic Hand Pump

INTENDED USE

Same as the model 910017B, but with a steel reservoir body, a manually activated push button for pumping and a lever for release of load. The pump operates in all positions for increased versatility in use and mounting.



MODEL NUMBER	HYDRAULIC PRESSURE RATING (P.S.I.)	USABLE OIL CAP. (Cu. In.)	OUTPUT FLOW RATE (Cu. In. Per Min.)		AIR PRESSURE RANGE (P.S.I.)	AIR CONSUMPTION (scfm)	VALVE FUNCTION	SOUND LEVEL (dBA)	THREAD CONNECTIONS		DIMENSIONS (Inches)			WEIGHT (Lbs.)
			No Load	Load					AIR (NPT)	HYDRAULIC (NPT)	Length	Width	Height	
910017B	10,000	127	60	10	25-125	12	Advance / Hold Retract	76	.25"-18	.375"-18	13.63"	6.19"	8.19"	14
910018B	10,000	462	60	10	25-125	12	Advance / Hold Retract	76	.25"-18	.375"-18	13.63"	12"	11.38"	38
910020	3,250	36	40	8	60-120	9	Advance / Hold Retract	85	.25"-18	.125"-27	15.5"	4.5"	5"	9
910130A	10,000	122	80.5	12.8	40-170	24	Advance / Hold Retract	85	.25"-18	.375"-18	12.5"	5.75"	8"	22
910140	10,000	462	80.5	12.8	40-170	24	Advance / Hold Retract	85	.25"-18	.375"-18	14"	8.5"	10.75"	44
910165	10,000	97	80.5	12.8	40-170	24	Advance / Hold Retract	85	.25"-18	.375"-18	10.25"	5.125"	7"	17

PORTABLE AND DURABLE HIGH PERFORMANCE

STEEL HAND PUMP FEATURES

925009A, 925010A, & 925013B

- 3/8 NPT hose connection on all pumps.
- Internal pressure relief valves for overload protection.
- External load release valve for single-acting cylinder operation.
- Two-speed pump operation on model 925013B for reduced operator fatigue.

LIGHTWEIGHT HAND PUMP FEATURES

925011, 925012A, & 925014

- Same as for the steel hand pumps but with the following additions:
- Durable glass-filled nylon reservoir and nylon encapsulated aluminum pump base for maximum corrosion resistance and lightweight handling.
 - Two-speed pump operation on models 925011 and 925014 reduces handle strokes by as much as 78% over single speed pumps.
 - Integral 4-way valve on the model 925014 for operation of double-acting cylinders.
 - Handle lock for easy carrying.
 - Non-conductive fiberglass handle for operator safety.



INTENDED USE

For many applications including shop, agricultural, automotive/truck service needs and construction maintenance applications where high pressure pumps are required to activate cylinders rated as high as 55 ton capacity.

NOTE: Models not shown have same basic construction as model pictured.

PUMP TYPE			MODEL NUMBER	PRESSURE RATING (P.S.I.)		USABLE OIL CAP. (Cu. In.)	OIL DISPLACEMENT PER STROKE (Cu. In.)		MAXIMUM HANDLE EFFORT (Lbs.)	PISTON STROKE (In.)	DIMENSIONS (Inches)			PUMP HANDLE ARC	WEIGHT (Lbs.)
Single Speed	Two Speed	Steel		Light Weight	1st. Stage		2nd. Stage	1st. Stage			2nd. Stage	Length	Width		
●		●		925009A	2,850	—	.16	—	57	.81	13.38	5.25	5.25	40°	11
●		●		925010A	10,000	—	.16	—	111	.81	23	5.25	5.25	40°	13
	●		●	925011	200	10,000	.687	.151	93	1.00	21.63	4.75	7	50°	9
●			●	925012A	10,000	—	.151	—	85	1.00	21.63	4.75	7	50°	9
	●	●		925013B	350	10,000	.99	.15	104	1.00	22.5	5.75	7	50°	24
	●		●	925014	400	10,000	2.40	.151	95	1.00	21.75	4.75	9	50°	22

BEST IN CLASS

910019B FEATURES

- Two-speed design reduces cycle times for improved productivity.
- Single-phase 115 VAC, 1 hp induction motor will start at full load and stand up to continuous duty applications. Requires a steady power supply.
- 10 foot pendant controls the motor operation.
- Manual advance/retract valve control for single-acting cylinders.
- LCD display provides a number of diagnostic and readout capabilities.



910052A

910052A FEATURES

- Lightweight and compact design.
- High strength molded shroud with integral easy-carry handle protects motor from contamination.
- 115 VAC, 1/2 hp motor operates on voltages as low as 60 volts.
- 10 foot pendant for operator safety.
- Two-speed motor design with 3-way 2-position valve for use with single-acting cylinders.

ELECTRO / HYDRAULIC PUMPS



910019B

910019B

10,000 P.S.I. Capacity "Z" Series

910052A

10,000 P.S.I. Capacity

INTENDED USE

Same as for the air/hydraulic pumps but will handle single-acting cylinders up to 100 ton. The added convenience of an electro-hydraulic pump reduces pumping time and effort.

NOTE: All electrical motors are warranted against defects in material and workmanship for one year from the date of end user's purchase.

MODEL NUMBER	HYDRAULIC PRESSURE RATING (P.S.I.)		USABLE OIL CAP. (Cu. In.)	OUTPUT FLOW RATE (Cu. In. Per Min.)		CURRENT DRAW (Amps)	MOTOR VOLTAGE (VAC)	SOUND LEVEL (dBA)	THREAD CONNECTION (NPT)	VALVE TYPE	DIMENSIONS (Inches)			WEIGHT (Lbs.)
	1st. Stage	2nd. Stage		1st. Stage	2nd. Stage						Length	Width	Height	
910019B	450	10,000	462	400	40	20	115	75	.375"-18	Advance / Retract	19	9.75	23	73
910052A	200	10,000	238	200	20	9.5	115	85	.375"-18	Advance / Hold Retract	14.5	12.25	14.75	31

Hoses & Couplers

INTENDED USE

These heavy duty hoses and couplers are used to join pumps and cylinders together (see pages 36-39).



FEATURES

- Heavy duty rubber hoses rated at 10,000 P.S.I. meet IJ-100 specifications. Hoses are rubber coated with 2 layers of braided steel and offer flexibility with little memory. Strain relief type fittings are crimped on for improved life and durability.
- Quick connect 3/8" high flow couplers allow fast set-up of hydraulic systems. All couplers include two-in-one dust cap for use on male and female coupler halves.

MODEL NUMBER	DESCRIPTION	CAPACITY	HOSE OR COUPLER I.D.	CONNECTION	WEIGHT
910035A	6.5' Long Hose	10,000 P.S.I.	.375"	.375 NPT Male Both Ends	4.5 lbs.
910036A	10' Long Hose	10,000 P.S.I.	.375"	.375 NPT Male Both Ends	7 lbs.
910037A	Coupler, Hose Half	10,000 P.S.I.	.375"	.375 NPT Male End	1 lb.
910038A	Coupler, Cylinder Half	10,000 P.S.I.	.375"	.375 NPT Female End	1 lb.

Bases, Saddles & Attachments

910043A & 925142A

Heavy duty bases provide firmer and more stable footing for cylinders.

910044A & 925143A

Threaded male connectors adapt bases to the cylinders.

910046A & 925141A

Grooved saddles protect the cylinder ends and provide a better gripping surface.

910048 & 925148

Threaded adapters screw into the tops of the cylinders and provide a threaded connection for other attachments.

910039 & 925045

Base attachments are bolted to the bottom of the cylinders and are internally threaded to receive other attachments.

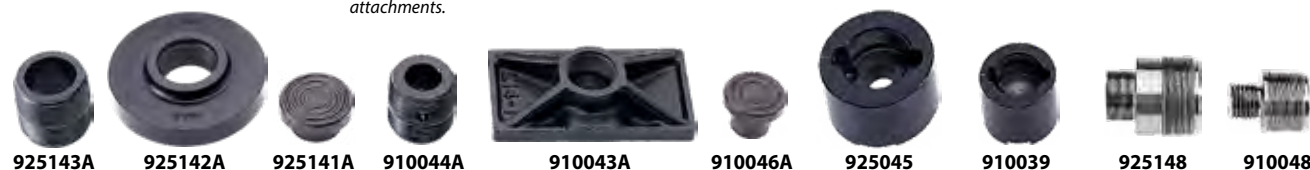

MODEL NUMBER	DESCRIPTION	CAPACITY	FOR USE ON CYLINDERS	CONNECTION (NPT)	WEIGHT
910043A	3.5" x 6.5" Base	5 Ton	10 Ton Cap.	1.25 x 11.5 Female	3.5 lbs.
925142A	6.5" Dia. Base	12-1/2 Ton	25 Ton Cap.	2 x 11.5 Female	9.5 lbs.
910044A	Male Connector	5 Ton	10 Ton Cap.	1.25 x 11.5 Male	0.5 lbs.
925143A	Male Connector	12-1/2 Ton	25 Ton Cap.	2 x 11.5 Male	4.5 lbs.
910046A	1.375" Dia. Grooved Saddle	10 Ton	10 & 15 Ton Cap.	—	0.5 lbs.
925141A	2" Dia. Grooved Saddle	25 Ton	25 Ton Cap.	—	0.5 lbs.
910048	Threaded Adapter	5 Ton	10 & 15 Ton Cap.	1.25 x 11.5 Male	1 lb.
925148	Threaded Adapter	12-1/2 Ton	25 Ton Cap.	2 x 11.5 Male	2.5 lbs.
910039	Base Attachment	5 Ton	10 Ton Cap.	1.25 x 11.5 Female	2 lbs.
925045	Base Attachment	12-1/2 Ton	25 Ton Cap.	2 x 11.5 Female	5.5 lbs.

910100B

Flow Control Valve

Manually adjusted fine metering valve rated at 10,000 P.S.I. that fits between the pump and cylinder. The valve controls the flow of oil returning to the reservoir when pressure is released. Valve includes 3/8" NPTF male and female connections. Weight: 1 lb.



MAX. 50% CAUTION!

When cylinders are used with maintenance set attachments or components, the maximum system pressure must be limited to half the rated pressure (5,000 P.S.I.).

A NATIONAL NETWORK OF AUTHORIZED SERVICE CENTERS PROVIDE PROFESSIONAL NORCO SERVICE AND REPAIR

NORCO's four distribution centers ensure quick delivery across North America.



LIMITED LIFETIME WARRANTY *Effective: February 25, 2010*

NORCO Professional Lifting Equipment's products and parts are warranted against defects in materials and workmanship for the life of the product or the part.

This warranty is expressly limited to persons who purchase NORCO products or parts for the purpose of resale or use in the ordinary course of the buyer's business.

This warranty does not cover any product or part that has been abused, misused, worn out, neglected, ground or otherwise altered, used for a purpose other than for which it was intended, or used in a manner inconsistent with any instructions regarding its use. In addition, this warranty does not cover any chains, batteries or electric motors, which are sold with NORCO products. All electric motors are separately warranted by their manufacturer under the conditions stated in the separate warranty.

THIS WARRANTY IS EXCLUSIVE AND NORCO MAKES NO OTHER WARRANTY OF ANY KIND, WHATSOEVER, EXPRESS OR IMPLIED, WITH RESPECT TO THE SPECIFIED PRODUCTS OR PARTS MANUFACTURED AND/OR SOLD BY IT, INCLUDING, BUT NOT LIMITED TO, IMPLIED WARRANTIES OF MERCHANTABILITY OR FITNESS FOR A PARTICULAR PURPOSE OR ANY OTHER MATTER. No agent, employee or representative of NORCO, or any other person, has authority to bind NORCO to any affirmation, representation or warranty concerning NORCO products or parts except as set forth herein.

If any NORCO product or part is determined by NORCO, in its sole judgment, to be defective, NORCO will, at its option, either repair or replace such defective product or part. THIS REMEDY SHALL BE THE EXCLUSIVE REMEDY AVAILABLE FOR ANY DEFECTIVE NORCO PRODUCT OR PART AND FOR ALL DAMAGES RESULTING FROM ANY CAUSE WHATSOEVER, INCLUDING, WITHOUT LIMITATION, NORCO'S NEGLIGENCE. IN NO EVENT SHALL NORCO BE LIABLE TO ANY BUYER OR OTHER PERSON FOR CONSEQUENTIAL OR INCIDENTAL DAMAGES OF ANY KIND OR NATURE WHATSOEVER, WHETHER FOR DEFECTIVE OR NONCONFORMING GOODS, OR UNDER ANY THEORY OF LIABILITY, INCLUDING, BUT NOT LIMITED TO, BREACH OF CONTRACT (EXPRESS OR IMPLIED), NEGLIGENCE, STRICT LIABILITY OR OTHERWISE. The purpose of this exclusive remedy shall be to provide the buyer with repair or replacement of NORCO products or parts determined by NORCO to be defective in material or workmanship. This (exclusive) remedy shall not be deemed to have failed of its essential purpose so long as NORCO is willing and able to repair or replace said defective product or part in the prescribed manner.

